

2021 SELECT METAL *Collection*



Midwest
Designer
Supply

888-523-2611



Select the Best SELECT METAL COLLECTION

The Select Metal Collection of drapery hardware offers the option of two distinctive collections of metal poles and accessories.

Select Metal is a premium collection of metal poles, accessories, and traverse rods all constructed using brass. This collection offers a choice of eight stunning finishes; Bronze, Brushed Brass, Graphite, Gunmetal, Matte Black, Polished Nickel, Satin Brass, and Steel. Poles, finials, and accessories are available in $\frac{3}{4}$ " and $1\frac{3}{16}$ " diameters.

Select Metal includes three traverse rod collections. The Brass Half Round Fascia and Metro Flat Fascia traverse rods are offered in eight finishes and assembled with Select Premium Track. The Cortina Collection includes three contemporary-styled track designs and are available in four finishes.

The Iron Works Collection features $\frac{3}{4}$ " and $1\frac{3}{16}$ " diameter steel poles and accessories in four finishes; Black, Black Copper, Black Pewter, and Sandstone. Iron Works includes nine finial designs and a variety of bracket options.

The Select Metal Collection provides beautiful drapery hardware of exceptional quality with the convenience of in-stock drapery hardware.

Placing Your Order

The color photos in this brochure are close representations of the finishes available. Please refer to your Select Product Binder #2019SWB or the Select Metal Finish Selector #2017SELM for actual finish samples.

Please Note

All items are sold as each.
Poles may be cut to a specified measurement for a surcharge.
Not recommended for outdoor use.

CONTENTS

Poles - Brass	5
Finials - Brass	6 - 21
Acrylic Poles and Rings	16
Acrylic Finials.....	17 - 19
Crystal Finials.....	20 - 21
Brackets - Brass	22 - 25
Batons.....	25
French Returns - Brass.....	26 - 28
Elbows - Brass.....	29
Curving and Bending - Brass	30 - 31
Rings - Brass	33
Metro - Brass.....	34 - 36
Rosettes - Brass.....	37
Café Rods and Swing Arms.....	38 - 39
Traverse Rods - Brass.....	40 - 46
Cortina Traverse Rods.....	47 - 51
Iron Works Poles	53
Iron Works Finials.....	54 - 56
Iron Works French Returns	57
Iron Works Brackets.....	58 - 59
Iron Works Accessories	60 - 61
Sales Aids	62



3/4" and 1 3/16"

POLES - Brass

3/4" Brass Poles - 6'

120-0006-07	Bronze
120-0006-22	Satin Brass
120-0006-27	Brushed Brass
120-0006-46	Matte Black
120-0006-48	Graphite
120-0006-65	Gunmetal
120-0006-67	Steel
120-0006-68	Polished Nickel

3/4" Brass Poles - 8'

120-0008-07	Bronze
120-0008-22	Satin Brass
120-0008-27	Brushed Brass
120-0008-46	Matte Black
120-0008-48	Graphite
120-0008-65	Gunmetal
120-0008-67	Steel
120-0008-68	Polished Nickel

3/4" Brass Poles - 12'

120-0012-07	Bronze
120-0012-22	Satin Brass
120-0012-27	Brushed Brass
120-0012-46	Matte Black
120-0012-48	Graphite
120-0012-65	Gunmetal
120-0012-67	Steel
120-0012-68	Polished Nickel

1 3/16" Brass Poles - 6'

130-0006-07	Bronze
130-0006-22	Satin Brass
130-0006-27	Brushed Brass
130-0006-46	Matte Black
130-0006-48	Graphite
130-0006-65	Gunmetal
130-0006-67	Steel
130-0006-68	Polished Nickel

1 3/16" Brass Poles - 8'

130-0008-07	Bronze
130-0008-22	Satin Brass
130-0008-27	Brushed Brass
130-0008-46	Matte Black
130-0008-48	Graphite
130-0008-65	Gunmetal
130-0008-67	Steel
130-0008-68	Polished Nickel

1 3/16" Brass Poles - 12'

130-0012-07	Bronze
130-0012-22	Satin Brass
130-0012-27	Brushed Brass
130-0012-46	Matte Black
130-0012-48	Graphite
130-0012-65	Gunmetal
130-0012-67	Steel
130-0012-68	Polished Nickel



Internal Pole Splice

120-4999-67 (3/4")
130-4999-67 (1 3/16")

1 3/16" Acrylic Poles

130-0006-01
130-0008-01
See Page 16

Finishes:

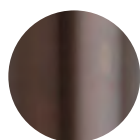

BRONZE
(07)



SATIN BRASS
(22)



BRUSHED BRASS
(27)



MATTE BLACK
(46)



GRAPHITE
(48)

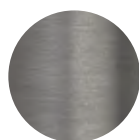

GUNMETAL
(65)

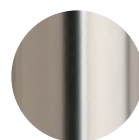

STEEL
(67)



POLISHED NICKEL
(68)

3/4" and 1 3/16"

FINIALS - Brass

Finial Diagrams include:

FINIAL DIMENSIONS: Length x Height

POLE INSET: This measurement gives the maximum length the pole can insert into the finial. Please note that pole inset will vary by finial design.

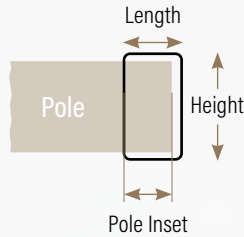



Nova Finial

$\frac{3}{4}$ " - L: 1" x H: $1\frac{1}{2}$ "
 $1\frac{3}{16}$ " - L: $1\frac{1}{2}$ " x H: $2\frac{3}{8}$ "



Opus Finial

$\frac{3}{4}$ " - L: $1\frac{3}{8}$ " x H: $1\frac{1}{2}$ "
 $1\frac{3}{16}$ " - L: $1\frac{3}{4}$ " x H: $2\frac{1}{4}$ "

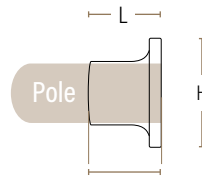

$\frac{3}{4}$ " Pole Inset - 1" • $1\frac{3}{16}$ " Pole Inset - $1\frac{3}{8}$ "

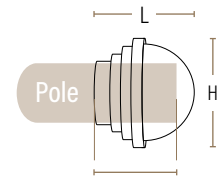

$\frac{3}{4}$ " Pole Inset - $1\frac{1}{8}$ " • $1\frac{3}{16}$ " Pole Inset - $1\frac{1}{2}$ "



BRONZE
 120-1054-07 ($\frac{3}{4}$ ")
 130-1054-07 ($1\frac{3}{16}$ ")



SATIN BRASS
 120-1054-22 ($\frac{3}{4}$ ")
 130-1054-22 ($1\frac{3}{16}$ ")



BRUSHED BRASS
 120-1054-27 ($\frac{3}{4}$ ")
 130-1054-27 ($1\frac{3}{16}$ ")



MATTE BLACK
 120-1054-46 ($\frac{3}{4}$ ")
 130-1054-46 ($1\frac{3}{16}$ ")



GRAPHITE
 120-1054-48 ($\frac{3}{4}$ ")
 130-1054-48 ($1\frac{3}{16}$ ")



GUNMETAL
 120-1054-65 ($\frac{3}{4}$ ")
 130-1054-65 ($1\frac{3}{16}$ ")



STEEL
 120-1054-67 ($\frac{3}{4}$ ")
 130-1054-67 ($1\frac{3}{16}$ ")



POLISHED NICKEL
 120-1054-68 ($\frac{3}{4}$ ")
 130-1054-68 ($1\frac{3}{16}$ ")



BRONZE
 120-1052-07 ($\frac{3}{4}$ ")
 130-1052-07 ($1\frac{3}{16}$ ")



SATIN BRASS
 120-1052-22 ($\frac{3}{4}$ ")
 130-1052-22 ($1\frac{3}{16}$ ")



BRUSHED BRASS
 120-1052-27 ($\frac{3}{4}$ ")
 130-1052-27 ($1\frac{3}{16}$ ")



MATTE BLACK
 120-1052-46 ($\frac{3}{4}$ ")
 130-1052-46 ($1\frac{3}{16}$ ")



GRAPHITE
 120-1052-48 ($\frac{3}{4}$ ")
 130-1052-48 ($1\frac{3}{16}$ ")



GUNMETAL
 120-1052-65 ($\frac{3}{4}$ ")
 130-1052-65 ($1\frac{3}{16}$ ")



STEEL
 120-1052-67 ($\frac{3}{4}$ ")
 130-1052-67 ($1\frac{3}{16}$ ")



POLISHED NICKEL
 120-1052-68 ($\frac{3}{4}$ ")
 130-1052-68 ($1\frac{3}{16}$ ")



End Cap

$\frac{3}{4}$ " - L: $\frac{5}{8}$ " x H: $\frac{7}{8}$ "
 $1\frac{3}{16}$ " - L: $\frac{3}{4}$ " x H: $1\frac{3}{8}$ "



Square End Cap

$\frac{3}{4}$ " - L: $\frac{5}{8}$ " x H: $1\frac{3}{8}$ "
 $1\frac{3}{16}$ " - L: $\frac{3}{4}$ " x H: 2"



Kingston Finial

$\frac{3}{4}$ " - L: $2\frac{1}{8}$ " x H: $1\frac{3}{8}$ "
 $1\frac{3}{16}$ " - L: $3\frac{5}{8}$ " x H: 2 $\frac{1}{4}$ "

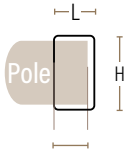

$\frac{3}{4}$ " Pole Inset - $\frac{1}{2}$ " • $1\frac{3}{16}$ " Pole Inset - $\frac{5}{8}$ "

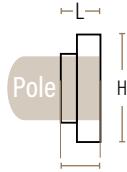

$\frac{3}{4}$ " Pole Inset - $\frac{1}{2}$ " • $1\frac{3}{16}$ " Pole Inset - $\frac{5}{8}$ "

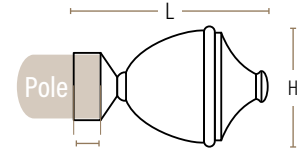

$\frac{3}{4}$ " Pole Inset - $\frac{3}{8}$ " • $1\frac{3}{16}$ " Pole Inset - $\frac{1}{2}$ "



BRONZE
 120-1080-07 ($\frac{3}{4}$ ")
 130-1080-07 ($1\frac{3}{16}$ ")



SATIN BRASS
 120-1080-22 ($\frac{3}{4}$ ")
 130-1080-22 ($1\frac{3}{16}$ ")



BRUSHED BRASS
 120-1080-27 ($\frac{3}{4}$ ")
 130-1080-27 ($1\frac{3}{16}$ ")



MATTE BLACK
 120-1080-46 ($\frac{3}{4}$ ")
 130-1080-46 ($1\frac{3}{16}$ ")



GRAPHITE
 120-1080-48 ($\frac{3}{4}$ ")
 130-1080-48 ($1\frac{3}{16}$ ")



GUNMETAL
 120-1080-65 ($\frac{3}{4}$ ")
 130-1080-65 ($1\frac{3}{16}$ ")



STEEL
 120-1080-67 ($\frac{3}{4}$ ")
 130-1080-67 ($1\frac{3}{16}$ ")



POLISHED NICKEL
 120-1080-68 ($\frac{3}{4}$ ")
 130-1080-68 ($1\frac{3}{16}$ ")



BRONZE
 120-1081-07 ($\frac{3}{4}$ ")
 130-1081-07 ($1\frac{3}{16}$ ")



SATIN BRASS
 120-1081-22 ($\frac{3}{4}$ ")
 130-1081-22 ($1\frac{3}{16}$ ")



BRUSHED BRASS
 120-1081-27 ($\frac{3}{4}$ ")
 130-1081-27 ($1\frac{3}{16}$ ")



MATTE BLACK
 120-1081-46 ($\frac{3}{4}$ ")
 130-1081-46 ($1\frac{3}{16}$ ")



GRAPHITE
 120-1081-48 ($\frac{3}{4}$ ")
 130-1081-48 ($1\frac{3}{16}$ ")



GUNMETAL
 120-1081-65 ($\frac{3}{4}$ ")
 130-1081-65 ($1\frac{3}{16}$ ")



STEEL
 120-1081-67 ($\frac{3}{4}$ ")
 130-1081-67 ($1\frac{3}{16}$ ")



POLISHED NICKEL
 120-1081-68 ($\frac{3}{4}$ ")
 130-1081-68 ($1\frac{3}{16}$ ")



BRONZE
 120-1076-07 ($\frac{3}{4}$ ")
 130-1076-07 ($1\frac{3}{16}$ ")



SATIN BRASS
 120-1076-22 ($\frac{3}{4}$ ")
 130-1076-22 ($1\frac{3}{16}$ ")



BRUSHED BRASS
 120-1076-27 ($\frac{3}{4}$ ")
 130-1076-27 ($1\frac{3}{16}$ ")



MATTE BLACK
 120-1076-46 ($\frac{3}{4}$ ")
 130-1076-46 ($1\frac{3}{16}$ ")



GRAPHITE
 120-1076-48 ($\frac{3}{4}$ ")
 130-1076-48 ($1\frac{3}{16}$ ")



GUNMETAL
 120-1076-65 ($\frac{3}{4}$ ")
 130-1076-65 ($1\frac{3}{16}$ ")



STEEL
 120-1076-67 ($\frac{3}{4}$ ")
 130-1076-67 ($1\frac{3}{16}$ ")



POLISHED NICKEL
 120-1076-68 ($\frac{3}{4}$ ")
 130-1076-68 ($1\frac{3}{16}$ ")





Landover Finial

$\frac{3}{4}$ " - L: $1\frac{7}{8}$ " x H: 2"
 $1\frac{3}{16}$ " - L: $2\frac{1}{2}$ " x H: $2\frac{1}{2}$ "

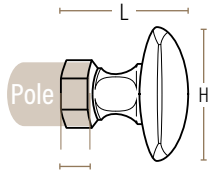

$\frac{3}{4}$ " Pole Inset - $\frac{3}{8}$ " - $1\frac{3}{16}$ " Pole Inset - $\frac{1}{2}$ "



BRONZE

120-1097-07 ($\frac{3}{4}$ "
 130-1097-07 ($1\frac{3}{16}$ ")



SATIN BRASS

120-1097-22 ($\frac{3}{4}$ "
 130-1097-22 ($1\frac{3}{16}$ ")



BRUSHED BRASS

120-1097-27 ($\frac{3}{4}$ "
 130-1097-27 ($1\frac{3}{16}$ ")



MATTE BLACK

120-1097-46 ($\frac{3}{4}$ "
 130-1097-46 ($1\frac{3}{16}$ ")



GRAPHITE

120-1097-48 ($\frac{3}{4}$ "
 130-1097-48 ($1\frac{3}{16}$ ")



GUNMETAL

120-1097-65 ($\frac{3}{4}$ "
 130-1097-65 ($1\frac{3}{16}$ ")



STEEL

120-1097-67 ($\frac{3}{4}$ "
 130-1097-67 ($1\frac{3}{16}$ ")



POLISHED NICKEL

120-1097-68 ($\frac{3}{4}$ "
 130-1097-68 ($1\frac{3}{16}$ ")





Cadet Finial

3/4" - L: 2 3/8" x H: 1 1/2"
 1 3/16" - L: 3 1/2" x H: 2 1/4"

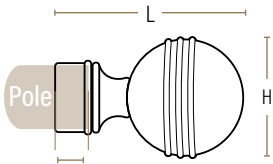

3/4" Pole Inset - 1/2" • 1 3/16" Pole Inset - 5/8"



Ball Finial

3/4" - L: 2 3/4" x H: 1 3/4"
 1 3/16" - L: 3 5/8" x H: 2 1/4"

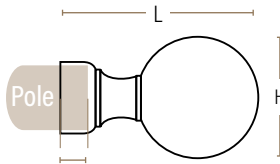

3/4" Pole Inset - 3/8" • 1 3/16" Pole Inset - 1/2"



Gala Finial

3/4" - L: 1 3/8" x H: 1 1/2"
 1 3/16" - L: 2 1/4" x H: 2 5/8"

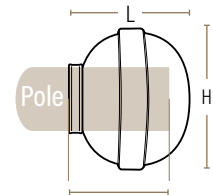

3/4" Pole Inset - 1 1/4" • 1 3/16" Pole Inset - 1 7/8"



BRONZE

120-1095-07 (3/4")
 130-1095-07 (1 3/16")



SATIN BRASS

120-1095-22 (3/4")
 130-1095-22 (1 3/16")



BRUSHED BRASS

120-1095-27 (3/4")
 130-1095-27 (1 3/16")



MATTE BLACK

120-1095-46 (3/4")
 130-1095-46 (1 3/16")



GRAPHITE

120-1095-48 (3/4")
 130-1095-48 (1 3/16")



GUNMETAL

120-1095-65 (3/4")
 130-1095-65 (1 3/16")



STEEL

120-1095-67 (3/4")
 130-1095-67 (1 3/16")



POLISHED NICKEL

120-1095-68 (3/4")
 130-1095-68 (1 3/16")



BRONZE

120-1071-07 (3/4")
 130-1071-07 (1 3/16")



SATIN BRASS

120-1071-22 (3/4")
 130-1071-22 (1 3/16")



BRUSHED BRASS

120-1071-27 (3/4")
 130-1071-27 (1 3/16")



MATTE BLACK

120-1071-46 (3/4")
 130-1071-46 (1 3/16")



GRAPHITE

120-1071-48 (3/4")
 130-1071-48 (1 3/16")



GUNMETAL

120-1071-65 (3/4")
 130-1071-65 (1 3/16")



STEEL

120-1071-67 (3/4")
 130-1071-67 (1 3/16")



POLISHED NICKEL

120-1071-68 (3/4")
 130-1071-68 (1 3/16")



BRONZE

120-1090-07 (3/4")
 130-1090-07 (1 3/16")



SATIN BRASS

120-1090-22 (3/4")
 130-1090-22 (1 3/16")



BRUSHED BRASS

120-1090-27 (3/4")
 130-1090-27 (1 3/16")



MATTE BLACK

120-1090-46 (3/4")
 130-1090-46 (1 3/16")



GRAPHITE

120-1090-48 (3/4")
 130-1090-48 (1 3/16")



GUNMETAL

120-1090-65 (3/4")
 130-1090-65 (1 3/16")



STEEL

120-1090-67 (3/4")
 130-1090-67 (1 3/16")



POLISHED NICKEL

120-1090-68 (3/4")
 130-1090-68 (1 3/16")



Modern Ball Finial

$\frac{3}{4}$ " - L: $1\frac{3}{8}$ " x H: $1\frac{1}{2}$ "
 $1\frac{3}{16}$ " - L: $1\frac{3}{4}$ " x H: 2"



Candler Finial

$\frac{3}{4}$ " - L: $1\frac{1}{4}$ " x H: $1\frac{1}{2}$ "
 $1\frac{3}{16}$ " - L: 2" x H: $2\frac{3}{8}$ "



Empire Finial

$\frac{3}{4}$ " - L: $2\frac{3}{4}$ " x H: $\frac{7}{8}$ "
 $1\frac{3}{16}$ " - L: $3\frac{3}{8}$ " x H: $1\frac{3}{8}$ "

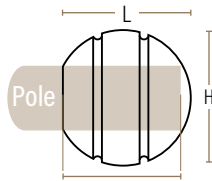

$\frac{3}{4}$ " Pole Inset - $1\frac{1}{4}$ " - $1\frac{3}{16}$ " Pole Inset - $1\frac{1}{2}$ "

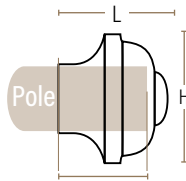

$\frac{3}{4}$ " Pole Inset - 1" - $1\frac{3}{16}$ " Pole Inset - $1\frac{5}{8}$ "

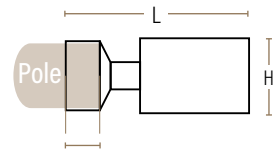

$\frac{3}{4}$ " Pole Inset - $\frac{1}{2}$ " - $1\frac{3}{16}$ " Pole Inset - $\frac{5}{8}$ "



BRONZE
 120-1085-07 ($\frac{3}{4}$ ")
 130-1085-07 ($1\frac{3}{16}$ ")



SATIN BRASS
 120-1085-22 ($\frac{3}{4}$ ")
 130-1085-22 ($1\frac{3}{16}$ ")



BRUSHED BRASS
 120-1085-27 ($\frac{3}{4}$ ")
 130-1085-27 ($1\frac{3}{16}$ ")



MATTE BLACK
 120-1085-46 ($\frac{3}{4}$ ")
 130-1085-46 ($1\frac{3}{16}$ ")



GRAPHITE
 120-1085-48 ($\frac{3}{4}$ ")
 130-1085-48 ($1\frac{3}{16}$ ")



GUNMETAL
 120-1085-65 ($\frac{3}{4}$ ")
 130-1085-65 ($1\frac{3}{16}$ ")



STEEL
 120-1085-67 ($\frac{3}{4}$ ")
 130-1085-67 ($1\frac{3}{16}$ ")



POLISHED NICKEL
 120-1085-68 ($\frac{3}{4}$ ")
 130-1085-68 ($1\frac{3}{16}$ ")



BRONZE
 120-1072-07 ($\frac{3}{4}$ ")
 130-1072-07 ($1\frac{3}{16}$ ")



SATIN BRASS
 120-1072-22 ($\frac{3}{4}$ ")
 130-1072-22 ($1\frac{3}{16}$ ")



BRUSHED BRASS
 120-1072-27 ($\frac{3}{4}$ ")
 130-1072-27 ($1\frac{3}{16}$ ")



MATTE BLACK
 120-1072-46 ($\frac{3}{4}$ ")
 130-1072-46 ($1\frac{3}{16}$ ")



GRAPHITE
 120-1072-48 ($\frac{3}{4}$ ")
 130-1072-48 ($1\frac{3}{16}$ ")



GUNMETAL
 120-1072-65 ($\frac{3}{4}$ ")
 130-1072-65 ($1\frac{3}{16}$ ")



STEEL
 120-1072-67 ($\frac{3}{4}$ ")
 130-1072-67 ($1\frac{3}{16}$ ")



POLISHED NICKEL
 120-1072-68 ($\frac{3}{4}$ ")
 130-1072-68 ($1\frac{3}{16}$ ")



BRONZE
 120-1074-07 ($\frac{3}{4}$ ")
 130-1074-07 ($1\frac{3}{16}$ ")



SATIN BRASS
 120-1074-22 ($\frac{3}{4}$ ")
 130-1074-22 ($1\frac{3}{16}$ ")



BRUSHED BRASS
 120-1074-27 ($\frac{3}{4}$ ")
 130-1074-27 ($1\frac{3}{16}$ ")



MATTE BLACK
 120-1074-46 ($\frac{3}{4}$ ")
 130-1074-46 ($1\frac{3}{16}$ ")



GRAPHITE
 120-1074-48 ($\frac{3}{4}$ ")
 130-1074-48 ($1\frac{3}{16}$ ")



GUNMETAL
 120-1074-65 ($\frac{3}{4}$ ")
 130-1074-65 ($1\frac{3}{16}$ ")



STEEL
 120-1074-67 ($\frac{3}{4}$ ")
 130-1074-67 ($1\frac{3}{16}$ ")



POLISHED NICKEL
 120-1074-68 ($\frac{3}{4}$ ")
 130-1074-68 ($1\frac{3}{16}$ ")



Windsor Finial

$\frac{3}{4}$ " - L: $1\frac{1}{4}$ " x H: $1\frac{1}{2}$ "
 $1\frac{3}{16}$ " - L: $1\frac{5}{8}$ " x H: $2\frac{3}{8}$ "

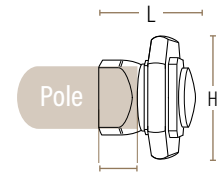

$\frac{3}{4}$ " Pole Inset - $\frac{1}{2}$ " • $1\frac{3}{16}$ " Pole Inset - $\frac{1}{2}$ "



BRONZE

120-1059-07 ($\frac{3}{4}$ "
 130-1059-07 ($1\frac{3}{16}$ "



SATIN BRASS

120-1059-22 ($\frac{3}{4}$ "
 130-1059-22 ($1\frac{3}{16}$ "



BRUSHED BRASS

120-1059-27 ($\frac{3}{4}$ "
 130-1059-27 ($1\frac{3}{16}$ "



MATTE BLACK

120-1059-46 ($\frac{3}{4}$ "
 130-1059-46 ($1\frac{3}{16}$ "



GRAPHITE

120-1059-48 ($\frac{3}{4}$ "
 130-1059-48 ($1\frac{3}{16}$ "



GUNMETAL

120-1059-65 ($\frac{3}{4}$ "
 130-1059-65 ($1\frac{3}{16}$ "



STEEL

120-1059-67 ($\frac{3}{4}$ "
 130-1059-67 ($1\frac{3}{16}$ "



POLISHED NICKEL

120-1059-68 ($\frac{3}{4}$ "
 130-1059-68 ($1\frac{3}{16}$ "



Back is solid

Tetra Finial

$\frac{3}{4}$ " - L: 2" x H: 1"
 $1 \frac{3}{16}$ " - L: $2 \frac{3}{8}$ " x H: $1 \frac{3}{8}$ "

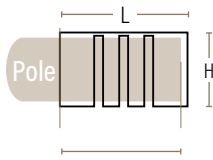

$\frac{3}{4}$ " Pole Inset - $1 \frac{7}{8}$ " • $1 \frac{3}{16}$ " Pole Inset - $2 \frac{1}{4}$ "



BRONZE
 120-1073-07 ($\frac{3}{4}$ ")
 130-1073-07 ($1 \frac{3}{16}$ ")



SATIN BRASS
 120-1073-22 ($\frac{3}{4}$ ")
 130-1073-22 ($1 \frac{3}{16}$ ")



BRUSHED BRASS
 120-1073-27 ($\frac{3}{4}$ ")
 130-1073-27 ($1 \frac{3}{16}$ ")



MATTE BLACK
 120-1073-46 ($\frac{3}{4}$ ")
 130-1073-46 ($1 \frac{3}{16}$ ")



GRAPHITE
 120-1073-48 ($\frac{3}{4}$ ")
 130-1073-48 ($1 \frac{3}{16}$ ")



GUNMETAL
 120-1073-65 ($\frac{3}{4}$ ")
 130-1073-65 ($1 \frac{3}{16}$ ")



STEEL
 120-1073-67 ($\frac{3}{4}$ ")
 130-1073-67 ($1 \frac{3}{16}$ ")



POLISHED NICKEL
 120-1073-68 ($\frac{3}{4}$ ")
 130-1073-68 ($1 \frac{3}{16}$ ")

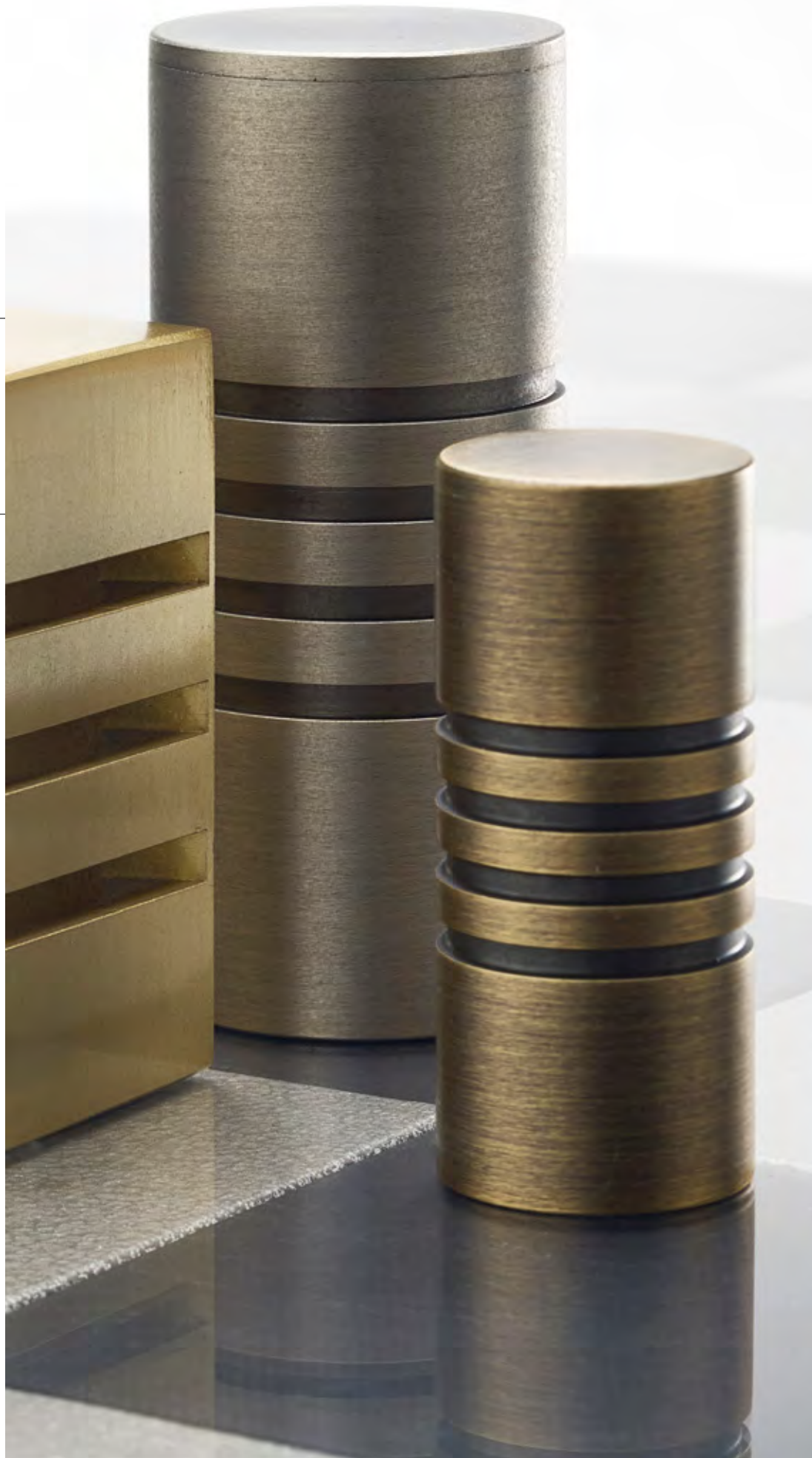



Urban Finial

3/4" - L: 2 1/8" x H: 7/8"
 1 3/16" - L: 3 1/8" x H: 1 3/8"



Gatsby Finial

3/4" - L: 2" x H: 1 3/8"
 1 3/16" - L: 2 1/2" x H: 2"



Aries Finial

3/4" - L: 7/8" x H: 1 3/8"
 1 3/16" - L: 1 1/4" x H: 2"

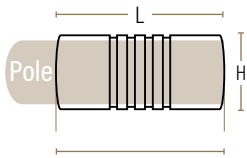

3/4" Pole Inset - 2 1/8" • 1 3/16" Pole Inset - 3 1/8"

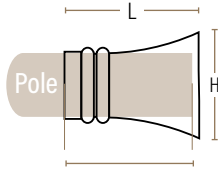

3/4" Pole Inset - 1 3/4" • 1 3/16" Pole Inset - 2 3/8"

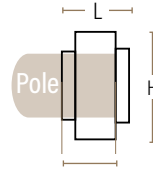

3/4" Pole Inset - 3/4" • 1 3/16" Pole Inset - 1"



BRONZE
 120-1075-07 (3/4")
 130-1075-07 (1 3/16")



SATIN BRASS
 120-1075-22 (3/4")
 130-1075-22 (1 3/16")



BRUSHED BRASS
 120-1075-27 (3/4")
 130-1075-27 (1 3/16")



MATTE BLACK
 120-1075-46 (3/4")
 130-1075-46 (1 3/16")



GRAPHITE
 120-1075-48 (3/4")
 130-1075-48 (1 3/16")



GUNMETAL
 120-1075-65 (3/4")
 130-1075-65 (1 3/16")



STEEL
 120-1075-67 (3/4")
 130-1075-67 (1 3/16")



POLISHED NICKEL
 120-1075-68 (3/4")
 130-1075-68 (1 3/16")



BRONZE
 120-1078-07 (3/4")
 130-1078-07 (1 3/16")



SATIN BRASS
 120-1078-22 (3/4")
 130-1078-22 (1 3/16")



BRUSHED BRASS
 120-1078-27 (3/4")
 130-1078-27 (1 3/16")



MATTE BLACK
 120-1078-46 (3/4")
 130-1078-46 (1 3/16")



GRAPHITE
 120-1078-48 (3/4")
 130-1078-48 (1 3/16")



GUNMETAL
 120-1078-65 (3/4")
 130-1078-65 (1 3/16")



STEEL
 120-1078-67 (3/4")
 130-1078-67 (1 3/16")



POLISHED NICKEL
 120-1078-68 (3/4")
 130-1078-68 (1 3/16")



BRONZE
 120-1077-07 (3/4")
 130-1077-07 (1 3/16")



SATIN BRASS
 120-1077-22 (3/4")
 130-1077-22 (1 3/16")



BRUSHED BRASS
 120-1077-27 (3/4")
 130-1077-27 (1 3/16")



MATTE BLACK
 120-1077-46 (3/4")
 130-1077-46 (1 3/16")



GRAPHITE
 120-1077-48 (3/4")
 130-1077-48 (1 3/16")



GUNMETAL
 120-1077-65 (3/4")
 130-1077-65 (1 3/16")



STEEL
 120-1077-67 (3/4")
 130-1077-67 (1 3/16")



POLISHED NICKEL
 120-1077-68 (3/4")
 130-1077-68 (1 3/16")



ACRYLIC

1 3/16" Acrylic Poles

Acrylic Poles are for light weight draperies. Center supports are recommended.

- 130-0006-01 (6')
- 130-0008-01 (8')

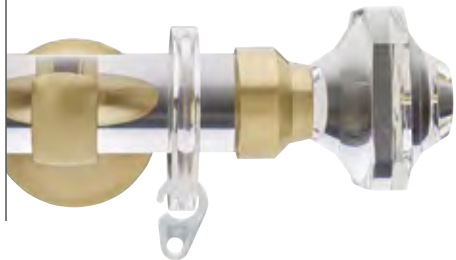

Connector Support Wall Bracket

Connector bracket available to support two acrylic poles for applications longer than 8 ft. See page 22 for product details and additional bracket options.



1 3/16" Acrylic Rings

See page 33 for additional ring options.

- 130-3700-01
- I.D.: 1 1/2", O.D.: 2 1/4"





Acrylic Ball Finial

3/4" - L: 2 7/8" x H: 1 7/8"
 1 3/16" - L: 3 3/8" x H: 2 1/4"



Acrylic Flare Finial

3/4" - L: 2" x H: 1 1/2"
 1 3/16" - L: 2 3/4" x H: 2"



Acrylic Mystic Finial

3/4" - L: 2" x H: 1 3/4"
 1 3/16" - L: 2 1/2" x H: 2 1/8"

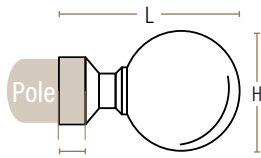

3/4" Pole Inset - 3/8" • 1 3/16" Pole Inset - 1/2"

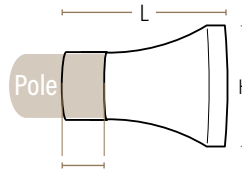

3/4" Pole Inset - 3/8" • 1 3/16" Pole Inset - 1/2"

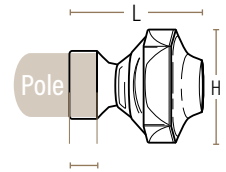

3/4" Pole Inset - 3/8" • 1 3/16" Pole Inset - 1/2"



BRONZE
 120-1070-07 (3/4")
 130-1070-07 (1 3/16")



SATIN BRASS
 120-1070-22 (3/4")
 130-1070-22 (1 3/16")



BRUSHED BRASS
 120-1070-27 (3/4")
 130-1070-27 (1 3/16")



MATTE BLACK
 120-1070-46 (3/4")
 130-1070-46 (1 3/16")



GRAPHITE
 120-1070-48 (3/4")
 130-1070-48 (1 3/16")



GUNMETAL
 120-1070-65 (3/4")
 130-1070-65 (1 3/16")



STEEL
 120-1070-67 (3/4")
 130-1070-67 (1 3/16")



POLISHED NICKEL
 120-1070-68 (3/4")
 130-1070-68 (1 3/16")



BRONZE
 120-1088-07 (3/4")
 130-1088-07 (1 3/16")



SATIN BRASS
 120-1088-22 (3/4")
 130-1088-22 (1 3/16")



BRUSHED BRASS
 120-1088-27 (3/4")
 130-1088-27 (1 3/16")



MATTE BLACK
 120-1088-46 (3/4")
 130-1088-46 (1 3/16")

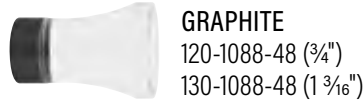

GRAPHITE
 120-1088-48 (3/4")
 130-1088-48 (1 3/16")



GUNMETAL
 120-1088-65 (3/4")
 130-1088-65 (1 3/16")



STEEL
 120-1088-67 (3/4")
 130-1088-67 (1 3/16")



POLISHED NICKEL
 120-1088-68 (3/4")
 130-1088-68 (1 3/16")



BRONZE
 120-1089-07 (3/4")
 130-1089-07 (1 3/16")



SATIN BRASS
 120-1089-22 (3/4")
 130-1089-22 (1 3/16")



BRUSHED BRASS
 120-1089-27 (3/4")
 130-1089-27 (1 3/16")



MATTE BLACK
 120-1089-46 (3/4")
 130-1089-46 (1 3/16")

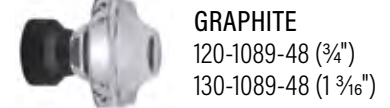

GRAPHITE
 120-1089-48 (3/4")
 130-1089-48 (1 3/16")



GUNMETAL
 120-1089-65 (3/4")
 130-1089-65 (1 3/16")



STEEL
 120-1089-67 (3/4")
 130-1089-67 (1 3/16")



POLISHED NICKEL
 120-1089-68 (3/4")
 130-1089-68 (1 3/16")



Deco Aries Finial

3/4" - L: 1 1/2" x H: 1 3/8"
 1 3/16" - L: 1 3/4" x H: 2"



Acrylic Aries Finial

3/4" - L: 1 1/4" x H: 1 3/8"
 1 3/16" - L: 1 1/2" x H: 2"

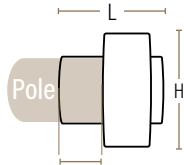

3/4" Pole Inset - 1/2" - 1 3/16" Pole Inset - 1/2"

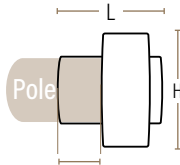

3/4" Pole Inset - 3/8" - 1 3/16" Pole Inset - 1/2"



BRONZE
 120-1057-07 (3/4")
 130-1057-07 (1 3/16")



SATIN BRASS
 120-1057-22 (3/4")
 130-1057-22 (1 3/16")



BRUSHED BRASS
 120-1057-27 (3/4")
 130-1057-27 (1 3/16")



MATTE BLACK
 120-1057-46 (3/4")
 130-1057-46 (1 3/16")



GRAPHITE
 120-1057-48 (3/4")
 130-1057-48 (1 3/16")



GUNMETAL
 120-1057-65 (3/4")
 130-1057-65 (1 3/16")



STEEL
 120-1057-67 (3/4")
 130-1057-67 (1 3/16")



POLISHED NICKEL
 120-1057-68 (3/4")
 130-1057-68 (1 3/16")



BRONZE
 120-1087-07 (3/4")
 130-1087-07 (1 3/16")



SATIN BRASS
 120-1087-22 (3/4")
 130-1087-22 (1 3/16")



BRUSHED BRASS
 120-1087-27 (3/4")
 130-1087-27 (1 3/16")



MATTE BLACK
 120-1087-46 (3/4")
 130-1087-46 (1 3/16")



GRAPHITE
 120-1087-48 (3/4")
 130-1087-48 (1 3/16")



GUNMETAL
 120-1087-65 (3/4")
 130-1087-65 (1 3/16")



STEEL
 120-1087-67 (3/4")
 130-1087-67 (1 3/16")



POLISHED NICKEL
 120-1087-68 (3/4")
 130-1087-68 (1 3/16")





Acrylic Halo Finial

$\frac{3}{4}$ " - L: $2\frac{1}{8}$ " x H: $2\frac{1}{8}$ "

$1\frac{1}{16}$ " - L: $2\frac{1}{2}$ " x H: $2\frac{1}{2}$ "

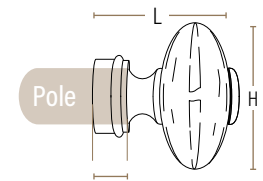

$\frac{3}{4}$ " Pole Inset - $\frac{1}{2}$ " • $1\frac{3}{16}$ " Pole Inset - $\frac{1}{2}$ "

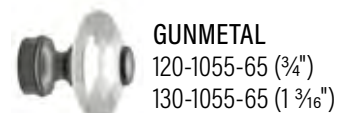
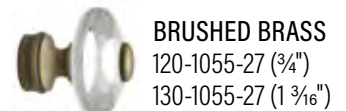
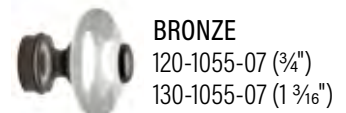

CRYSTAL





**Stella Finial
Crystal**

1 3/16" Only - L: 3" x H: 2"

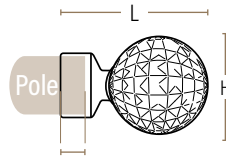

1 3/16" Pole Inset - 1/2"







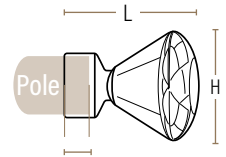



**Solitaire Finial
Crystal**

1 3/16" Only - L: 2 3/4" x H: 2 1/4"



1 3/16" Pole Inset - 1/2"

-  **BRONZE**
130-1091-07 (1 3/16")
-  **SATIN BRASS**
130-1091-22 (1 3/16")
-  **BRUSHED BRASS**
130-1091-27 (1 3/16")
-  **MATTE BLACK**
130-1091-46 (1 3/16")
-  **GRAPHITE**
130-1091-48 (1 3/16")
-  **GUNMETAL**
130-1091-65 (1 3/16")
-  **STEEL**
130-1091-67 (1 3/16")
-  **POLISHED NICKEL**
130-1091-68 (1 3/16")

-  **BRONZE**
130-1092-07 (1 3/16")
-  **SATIN BRASS**
130-1092-22 (1 3/16")
-  **BRUSHED BRASS**
130-1092-27 (1 3/16")
-  **MATTE BLACK**
130-1092-46 (1 3/16")
-  **GRAPHITE**
130-1092-48 (1 3/16")
-  **GUNMETAL**
130-1092-65 (1 3/16")
-  **STEEL**
130-1092-67 (1 3/16")
-  **POLISHED NICKEL**
130-1092-68 (1 3/16")

3/4" and 1 3/16"

BRACKETS - Brass

Standard Ceiling Bracket

120-2053 (3/4") Drop: 3"
 130-2053 (1 3/16") Drop: 3"
 Available in all finishes

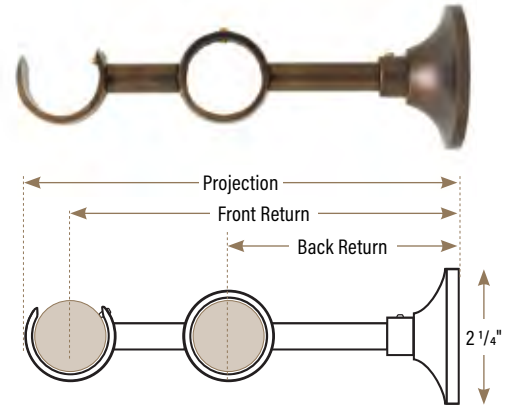
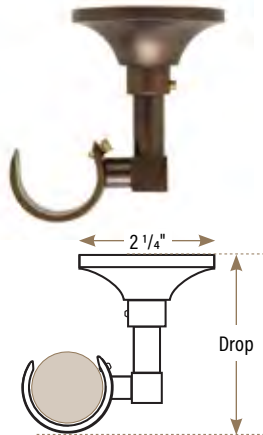

Standard Double Wall Bracket

120-2036 (3/4") Front Pole: 3/4", Back Pole: 3/4"
 Front Return: 5 3/4", Back Return: 3 1/2", Projection: 6 1/4"
 130-2036 (1 3/16") Front Pole: 1 3/16", Back Pole: 1 3/16"
 Front Return: 6 1/2", Back Return: 3 3/4", Projection: 7 1/4"
 Post may be cut for shorter projection
 Available in all finishes

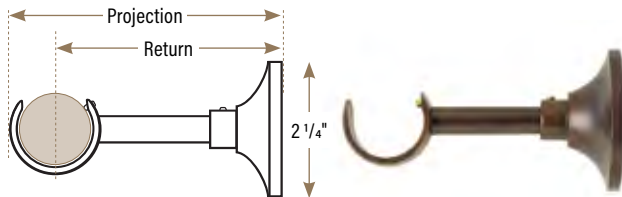

Standard Wall Bracket

120-2003 (3/4") Return: 3 1/2", Projection: 4 1/8"
 130-2003 (1 3/16") Return: 3 3/4", Projection: 4 1/2"
 Post may be cut for shorter projection
 Available in all finishes



Standard Extended Wall Bracket

120-2006 (3/4") Return: 5 3/4", Projection: 6 1/4"
 130-2006 (1 3/16") Return: 6 1/2", Projection: 7 1/4"
 Post may be cut for shorter projection
 Available in all finishes

Inside Mount Recess Bracket

120-2000 (3/4") L: 3/4" x H: 1 1/4", Pole Inset - 1/2"
 130-2000 (1 3/16") L: 1" x H: 1 3/4", Pole Inset - 3/4"
 Available in all finishes

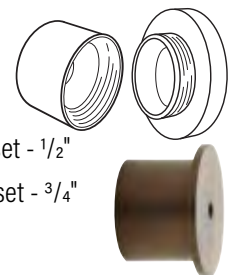

1 3/16" Connector Support Wall Bracket

130-2083 Return: 3 3/4", Projection: 4 1/2"
 130-2086 Return: 6 1/2", Projection: 7 1/4"
 Post may be cut for shorter projection
 Available in all finishes

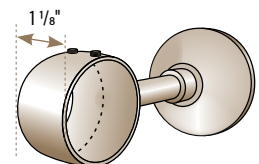

Finishes:

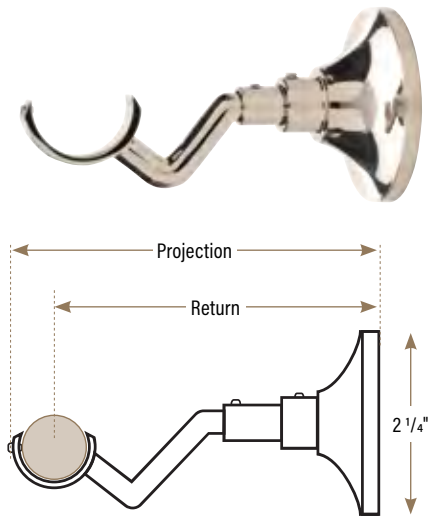
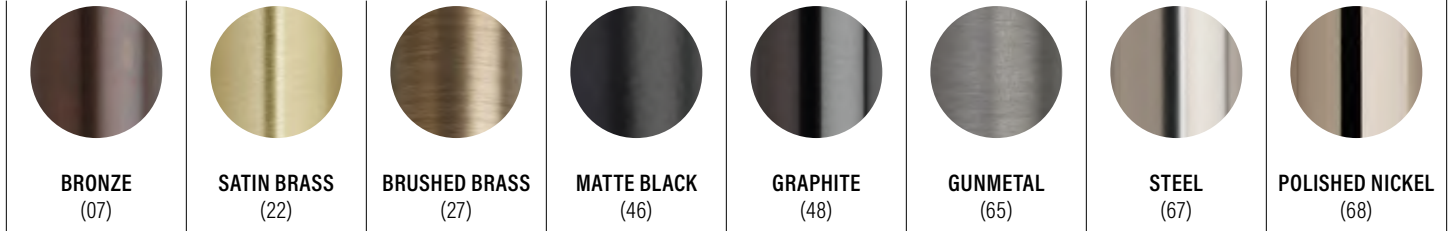

Standard By-Pass Bracket

120-2023 (3/4") Return: 3 1/2", Projection: 4 1/8"

130-2023 (1 3/16") Return: 3 3/4", Projection: 4 1/2"

Available in all finishes



Standard Extended By-Pass Bracket

120-2026 (3/4") Return: 5 3/4" Return, Projection: 6 1/4"

130-2026 (1 3/16") Return: 6 1/2" Return, Projection: 7 1/4"

Available in all finishes

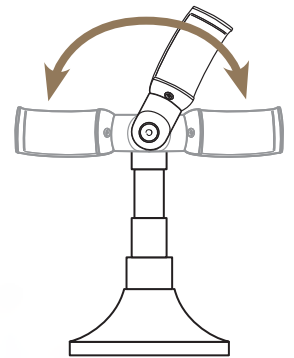
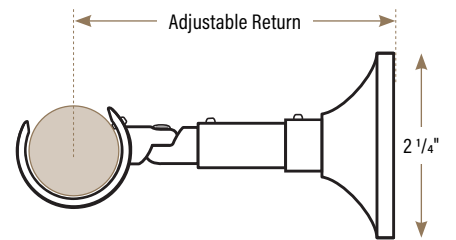

Adjustable Swivel Bracket

120-2056 (3/4") Return: 4 3/8" - 5 3/8"

130-2056 (1 3/16") Return: 4 1/2" - 5 1/2"

Available in all finishes

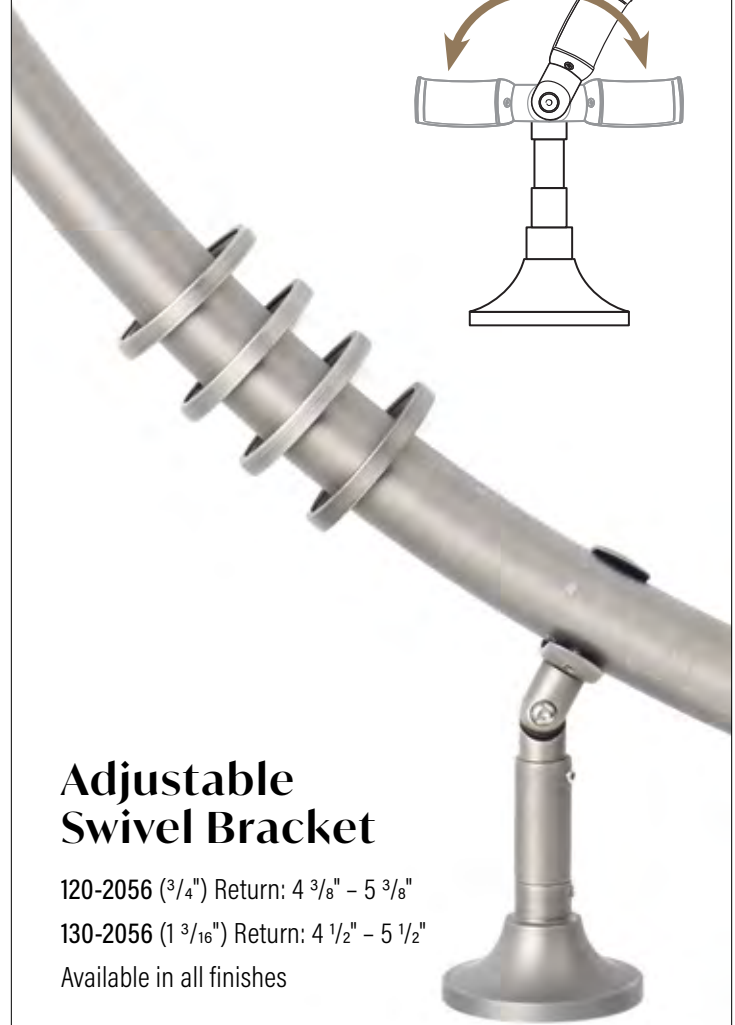



3/4" and 1 3/16" SQUARE BRACKETS - Brass

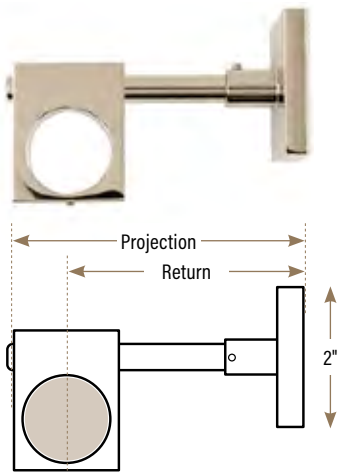

Square Wall Bracket

120-2103 (3/4") Return: 3 3/4", Projection: 4 1/4"

130-2103 (1 3/16") Return: 3 1/2", Projection: 4 1/4"

Post may be cut for shorter projection

Available in all finishes



Square Extended Wall Bracket

120-2107 (3/4") Return: 7 1/4", Projection: 7 3/4"

130-2107 (1 3/16") Return: 7", Projection: 7 3/4"

Post may be cut for shorter projection

Available in all finishes

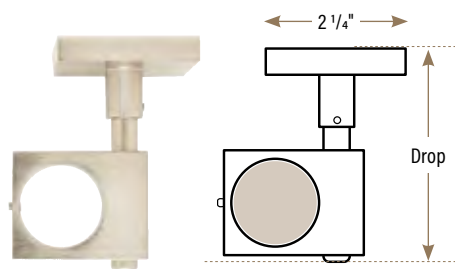

Square Ceiling Bracket

120-2153 (3/4") Drop: 2 3/4"

130-2153 (1 3/16") Drop: 3"

Available in all finishes

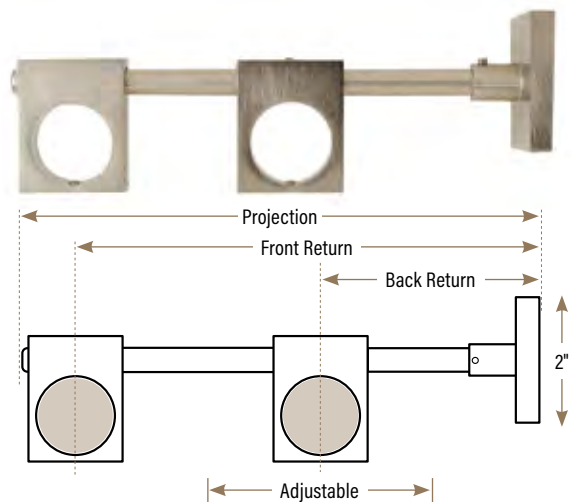

Square Double Wall Bracket

120-2137 (3/4") Front Pole: 3/4", Back Pole: 3/4"

Front Return: 7 1/4", Adjustable Back Return, Projection: 7 3/4"

130-2137 (1 3/16") Front Pole: 1 3/16", Back Pole: 1 3/16"

Front Return: 7", Adjustable Back Return, Projection: 7 3/4"

Post may be cut for shorter projection

Available in all finishes

3/4" and 1 3/16" URBAN BRACKETS - Brass

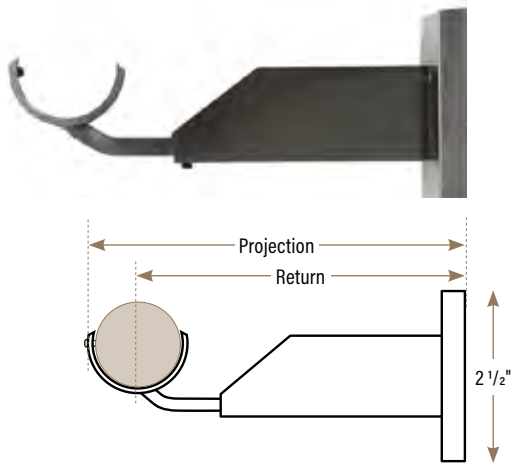

Urban Wall Bracket with By-Pass Option

120-2403 (3/4") Return: 3 3/4", Projection: 4 3/8"

130-2403 (1 3/16") Return: 5", Projection: 5 5/8"

Available in all finishes

Urban bracket includes by-pass option

Urban Brackets cannot be used with other brackets

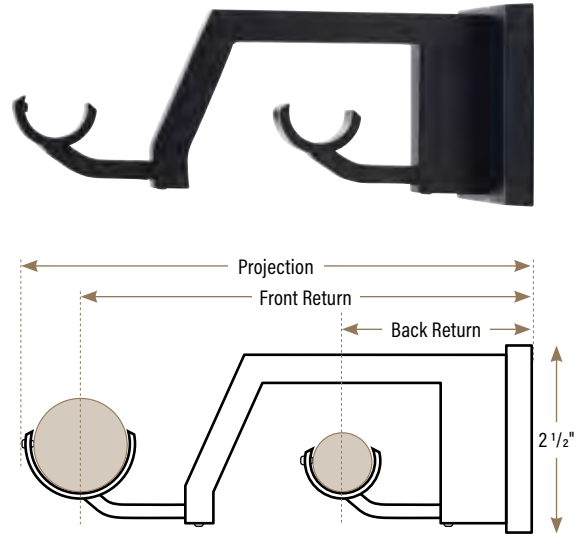

Urban Double Wall Bracket with By-Pass Option

120-2436 (3/4") Front Pole: 3/4", Back Pole : 3/4"
Front Return: 5 3/4", Back Return: 2 1/2", Projection: 6 3/8"

130-2436 (1 3/16") Front Pole: 1 3/16", Back Pole: 3/4"
Front Return: 6", Back Return: 2 1/2", Projection: 6 5/8"

Available in all finishes

Urban bracket includes by-pass option

BATONS

500-4700 Metal Baton, Length: 39"

500-4300 Heavy Duty Plexi Baton, Length: 39"





Featuring Select Metal
French Returns used with
90° Curved Corner Elbows.



3/4" and 1 3/16"

FRENCH RETURNS - Brass

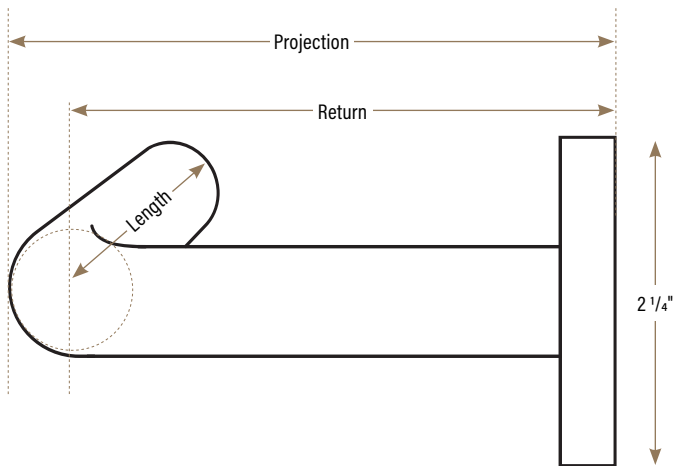

A Center Support Bracket is required for all French Return installations. See pages 22-23 for options



BRONZE (07)



GRAPHITE (48)



SATIN BRASS (22)



GUNMETAL (65)



BRUSHED BRASS (27)



STEEL (67)



MATTE BLACK (46)



POLISHED NICKEL (68)



French Return Elbow

120-4063 (3/4") Return: 3 1/2", Projection: 4 1/8", Length: 5"

130-4063 (1 3/16") Return: 3 3/4", Projection: 4 1/2", Length: 5"

Extended French Return Elbow

120-4066 (3/4") Return: 5 3/4", Projection: 6 1/4", Length: 5"

130-4066 (1 3/16") Return: 6 1/2", Projection: 7 1/4", Length: 5"

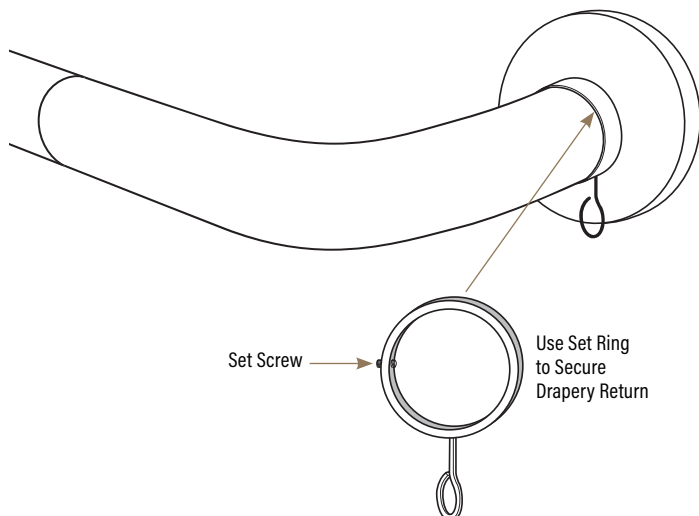

Internal Connector

Used to connect French Return to the pole.
Included

French Return Set Ring

120-3966 (3/4")

130-3966 (1 3/16")

Available in all finishes





Hinged Elbow

120-4053 ($\frac{3}{4}$ "

L: $1\frac{3}{4}$ " x L: $1\frac{3}{4}$ ", Pole Inset: $\frac{5}{8}$ "

130-4053 ($1\frac{3}{16}$ "

L: $2\frac{1}{8}$ " x L: $2\frac{1}{8}$ ", Pole Inset: $\frac{5}{8}$ "

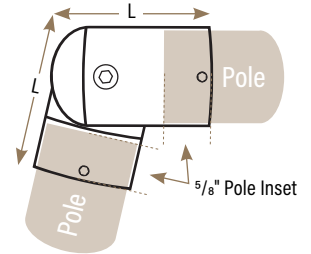

BRONZE
(07)



SATIN BRASS
(22)



BRUSHED BRASS
(27)



MATTE BLACK
(46)



GRAPHITE
(48)



GUNMETAL
(65)



STEEL
(67)



POLISHED NICKEL
(68)

$\frac{3}{4}$ " and $1\frac{3}{16}$ "

Elbows - Brass

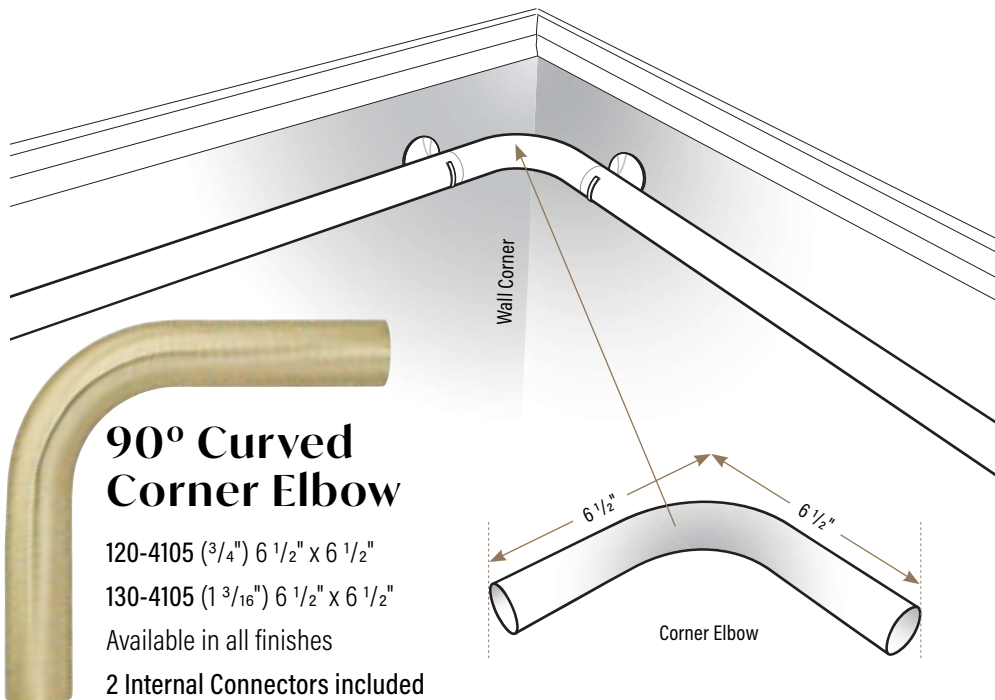

90° Curved Corner Elbow

120-4105 ($\frac{3}{4}$ " 6 $\frac{1}{2}$ " x 6 $\frac{1}{2}$ "

130-4105 ($1\frac{3}{16}$ " 6 $\frac{1}{2}$ " x 6 $\frac{1}{2}$ "

Available in all finishes

2 Internal Connectors included



CURVED POLES - Brass

Select Metal $\frac{3}{4}$ " and $1\frac{3}{16}$ " Poles may be continuous curved for bow or arched windows.

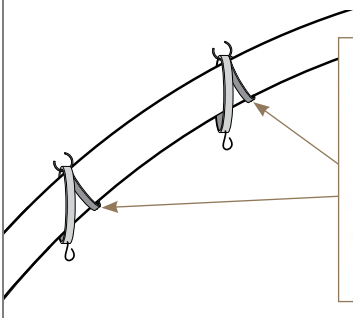

Set Rings for Arched Poles

Set Rings may be used with Select Metal Round or Flat Rings and allow for placement of rings at any position on the pole and may easily be adjusted.

120-3900 ($\frac{3}{4}$ "

130-3900 ($1\frac{3}{16}$ "

Available in all finishes

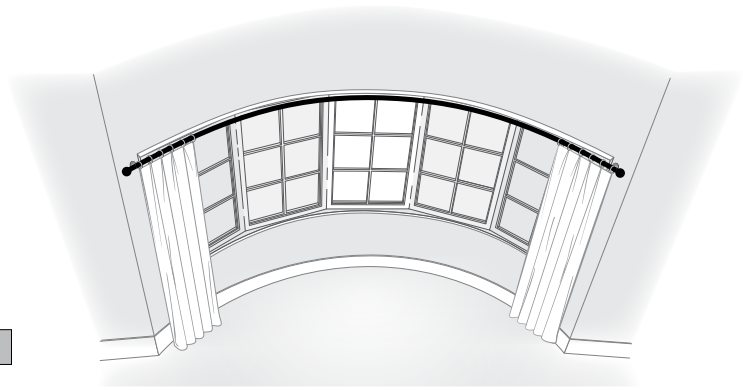
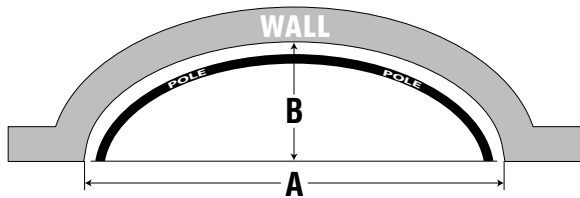

Curved Poles are ordered and priced by the foot.

A Template is required for all curved orders.
Curving and crating charges will apply.

Please see Price List for complete ordering and pricing information.
Brackets, Finials, and Rings must be specified and priced separately.

BENT POLES - Brass

Select Metal $\frac{3}{4}$ " and $1\frac{3}{16}$ " Poles may be bent for corner and bay windows.

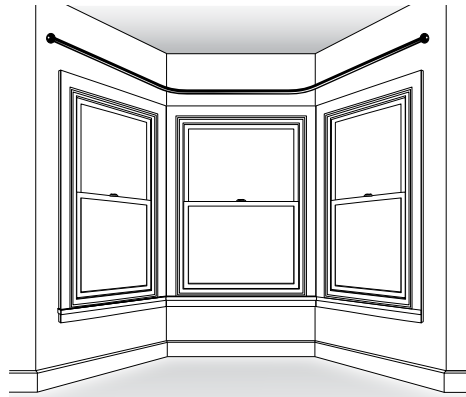
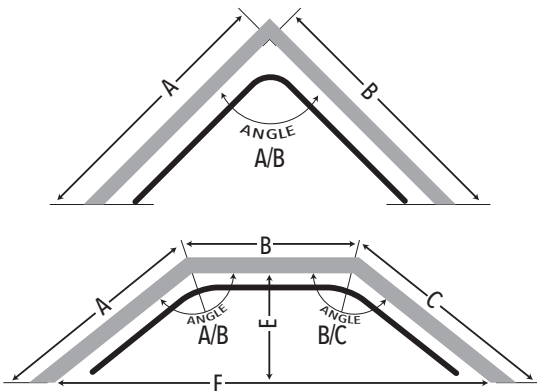

Bent Poles are ordered and priced by the foot.

A Template is required for all bent orders.
Bending and crating charges will apply.

Please see Price List for complete ordering and pricing information.
Brackets, Finials and Rings must be specified and priced separately.



Adjustable Swivel Bracket may be used with Bent or Curved Poles

For use with $\frac{3}{4}$ " or $1\frac{3}{16}$ " curved or bent poles
when installation requires more flexibility.
See pages 22-23 for all bracket options

120-2056 ($\frac{3}{4}$ ") Return: $4\frac{3}{8}$ "- $5\frac{3}{8}$ "
130-2056 ($1\frac{3}{16}$ ") Return: $4\frac{1}{2}$ "- $5\frac{1}{2}$ "
Available in all finishes



3/4" and 1 3/16"

RINGS - Brass

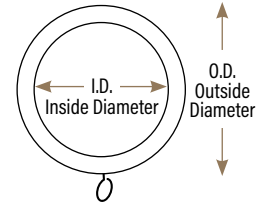

Round Ring with Liner

120-3000 (3/4") I.D.: 1 1/4", O.D.: 1 3/4"

130-3000 (1 3/16") I.D.: 1 5/8", O.D.: 2 3/8"

Available in all finishes



Square Ring with Liner

120-3100 (3/4") I.D.: 1 1/8", O.D.: 1 3/4" Square

130-3100 (1 3/16") I.D.: 1 1/2", O.D.: 2 1/4" Square

Available in all finishes



Flat Ring with Liner

120-3600 (3/4") I.D.: 1 1/8", O.D.: 1 1/2"

130-3600 (1 3/16") I.D.: 1 3/4", O.D.: 2"

Available in all finishes



Flat By-Pass Ring with Liner

120-3400 (3/4") I.D.: 1 1/4", O.D.: 1 5/8"

130-3400 (1 3/16") I.D.: 1 5/8", O.D.: 2"

Available in all finishes

Acrylic Ring

130-3700-01 (1 3/16") I.D.: 1 1/2", O.D.: 2 1/4"



Finishes:

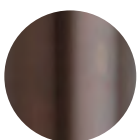

BRONZE
(07)



SATIN BRASS
(22)



BRUSHED BRASS
(27)

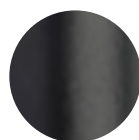

MATTE BLACK
(46)

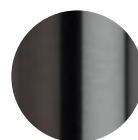

GRAPHITE
(48)

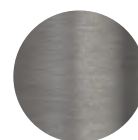

GUNMETAL
(65)



STEEL
(67)



POLISHED NICKEL
(68)

METRO - Brass





Metro End Cap

L: 1/2" x H: 1 1/2"



Metro Finial

L: 3/4" x H: 2"

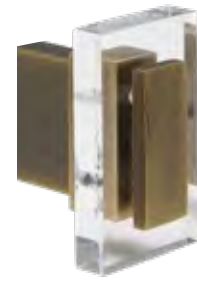

Metro Acrylic Finial

L: 1" x H: 2 3/8"

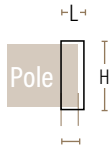

Pole Inset - 3/8"

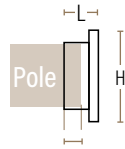

Pole Inset - 3/8"

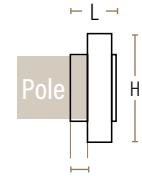

Pole Inset - 3/8"



BRONZE
135-0164-07



SATIN BRASS
135-0164-22



BRUSHED BRASS
135-0164-27



MATTE BLACK
135-0164-46



GRAPHITE
135-0164-48



GUNMETAL
135-0164-65



STEEL
135-0164-67



POLISHED NICKEL
135-0164-68



BRONZE
135-0184-07



SATIN BRASS
135-0184-22



BRUSHED BRASS
135-0184-27



MATTE BLACK
135-0184-46



GRAPHITE
135-0184-48



GUNMETAL
135-0184-65



STEEL
135-0184-67



POLISHED NICKEL
135-0184-68



BRONZE
135-0187-07



SATIN BRASS
135-0187-22



BRUSHED BRASS
135-0187-27



MATTE BLACK
135-0187-46



GRAPHITE
135-0187-48



GUNMETAL
135-0187-65



STEEL
135-0187-67



POLISHED NICKEL
135-0187-68

METRO - Brass



Metro Pole

135-0516 (1 3/8") Available up to 16'
Cut to exact measurement
Available in all finishes



Metro Ring with Liner

135-3800 W: 1 1/4" x H: 2 3/8"
Available in all finishes

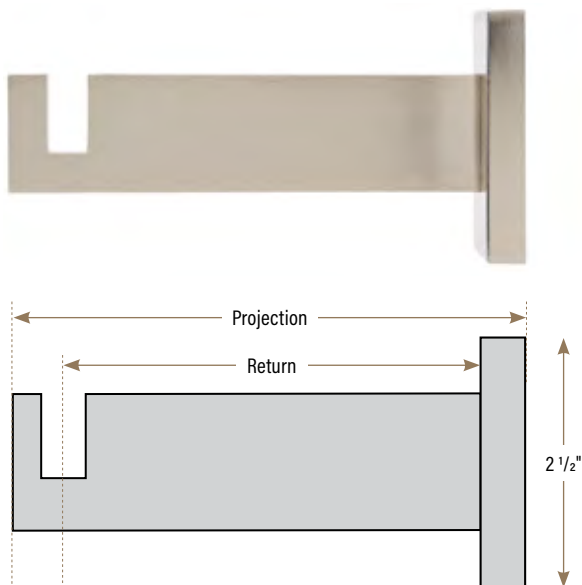

Metro Bracket

135-2804 Return: 4 1/2", Projection: 5 1/8"
Available in all finishes

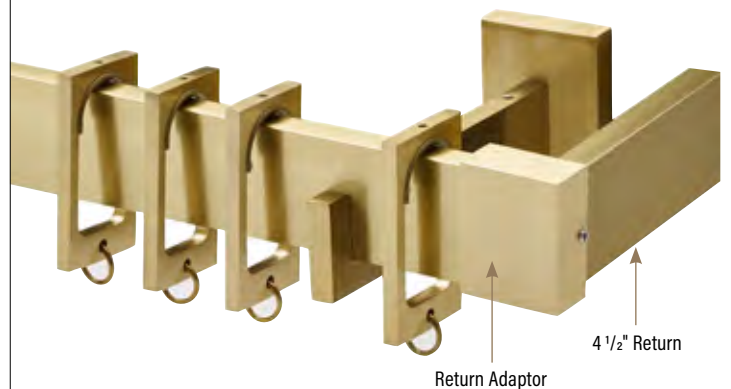

Metro Return Adaptor

135-4080 L: 1 1/4" x H: 1 1/2"
4 1/2" return included
Available in all finishes

Metro Internal Splice

135-4088-67
Splice must be at location of bracket



ROSETTES - Brass

Classic Rosette

2 3/4" Diameter



BRONZE
500-7032-07



SATIN BRASS
500-7032-22



BRUSHED BRASS
500-7032-27



MATTE BLACK
500-7032-46



GRAPHITE
500-7032-48



GUNMETAL
500-7032-65



STEEL
500-7032-67



POLISHED NICKEL
500-7032-68

Urban Rosette

2 1/4" Diameter



BRONZE
500-7052-07



SATIN BRASS
500-7052-22



BRUSHED BRASS
500-7052-27



MATTE BLACK
500-7052-46



GRAPHITE
500-7052-48



GUNMETAL
500-7052-65



STEEL
500-7052-67



POLISHED NICKEL
500-7052-68

Square Rosette

2" Square



BRONZE
500-7112-07



SATIN BRASS
500-7112-22



BRUSHED BRASS
500-7112-27



MATTE BLACK
500-7112-46



GRAPHITE
500-7112-48



GUNMETAL
500-7112-65



STEEL
500-7112-67



POLISHED NICKEL
500-7112-68



Spindles



500-7012 Projection: 2 1/8", Height: 1 3/8"

500-7014 Projection: 3 3/4", Height: 1 3/8"

Available in all finishes. **Spindles sold separately.**

Spindle posts may be connected together for additional projection.

CAFÉ RODS and SWING ARMS - Brass



1/2" Café Rods - 3'

- 112-0003-22 Satin Brass
- 112-0003-46 Matte Black
- 112-0003-67 Steel

1/2" Café Rods - 6'

- 112-0006-22 Satin Brass
- 112-0006-46 Matte Black
- 112-0006-67 Steel

Aries Finial pictured, Ball Finial also available. Finials sold separately.



Café Rod Bracket

- 112-2001 (1/2") Closed
- 112-2011 (1/2") Open
- Return: 1 1/2", Clearance: 1 1/4"
- Available in finishes 22, 46, 67



Café Rod Inside Mount Recess Bracket

- 112-2000 (1/2")
- L: 1/2" x H: 5/8"
- Available in finishes 22, 46, 67

5/8" Swing Arms - 20"

- 116-4620-22 Satin Brass
- 116-4620-46 Matte Black
- 116-4620-67 Steel



5/8" Swing Arms - 30"

- 116-4630-22 Satin Brass
- 116-4630-46 Matte Black
- 116-4630-67 Steel



Finials sold separately.

Mounting Plate W: 1 3/8" x H: 2 3/8"



ACCESSORIES

for use with Café Rods
and Swing Arms

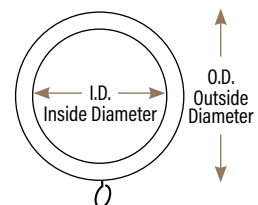

Aries Finial

Café Rod - L: $\frac{5}{8}$ " x H: $\frac{7}{8}$ "
Swing Arm - L: $\frac{3}{4}$ " x H: 1"

Ball Finial

Café Rod - L: 1" L x H: $\frac{5}{8}$ "
Swing Arm - L: 1 $\frac{1}{4}$ " L x H: $\frac{7}{8}$ "

Rings with Liner

I.D.: $\frac{3}{4}$ ", O.D.: 1 $\frac{1}{8}$ "
10 per package



SATIN BRASS
112-1077-22 (Café Rod)
116-1077-22 (Swing Arm)



MATTE BLACK
112-1077-46 (Café Rod)
116-1077-46 (Swing Arm)



STEEL
112-1077-67 (Café Rod)
116-1077-67 (Swing Arm)



SATIN BRASS
112-1071-22 (Café Rod)
116-1071-22 (Swing Arm)



MATTE BLACK
112-1071-46 (Café Rod)
116-1071-46 (Swing Arm)



STEEL
112-1071-67 (Café Rod)
116-1071-67 (Swing Arm)



SATIN BRASS
112-3000-22



MATTE BLACK
112-3000-46



STEEL
112-3000-67

TRAVERSE RODS- Brass





Select Metal Brass Traverse Rods

Select Metal Traverse Rods offer the beauty of a decorative pole with the functionality of a traverse rod.

Available with 1 3/16" Half Round Fascia and 1 3/8" Metro Flat Fascia assembled with the Select Premium track. The Premium 2-wheeled carriers allow a smooth operation for all drapery treatments. All specifications and ordering information can be referenced in the price list.

Select Metal Traverse Rods Feature:

Heavy Duty Tracks – 4 lbs. per foot.

Choice of Select Metal Half Round or Metro Flat Fascia.

Available for Pinch Pleat or Ripplefold® Draperies.

Double Traverse Rods are available with back rod as "track only" or with Select Metal Fascia.

Choice of 25 finial designs (see pages 6 - 21) or French Returns for 1 3/16" Half Round Fascia.

Choice of 3 finial designs (see page 35) or a Metro Return Adaptor for 1 3/8" Metro Flat Fascia.

Continuous Curve Half Round Traverse Rods available.

Decorative Round and Square Brackets are available for a surcharge.



Select Metal Finial Adaptor

Select Metal Finial attaches to adaptor for Half Round Fascia. Included



Finishes:

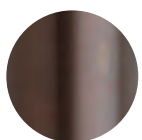

BRONZE
(07)

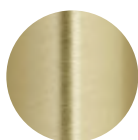

SATIN BRASS
(22)



BRUSHED BRASS
(27)



MATTE BLACK
(46)



GRAPHITE
(48)

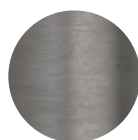

GUNMETAL
(65)



STEEL
(67)



POLISHED NICKEL
(68)

TRAVERSE RODS - Brass



French Returns for Half Round Traverse Rods

130-4164 (1 3/16") Return: 4"

French Returns are available for 1 3/16" Select Metal Half Round Traverse Rods.

Shown with the Round Decorative Bracket, available for a surcharge.



BRONZE (07)



GRAPHITE (48)



SATIN BRASS (22)



GUNMETAL (65)



BRUSHED BRASS (27)



STEEL (67)



MATTE BLACK (46)



POLISHED NICKEL (68)



Shown with optional Splice Cover 130-4009



Metro Return Adaptor

135-4080 L: 1 1/4" x H: 1 1/2"

The Metro Return Adaptor allows for a contemporary finished return to the wall.

The Return Adaptor includes the fascia return. Return length must be specified.



BRONZE (07)



GRAPHITE (48)



SATIN BRASS (22)



GUNMETAL (65)



BRUSHED BRASS (27)



STEEL (67)



MATTE BLACK (46)



POLISHED NICKEL (68)

French Return Set Ring

130-3916

Two adjustable French Return Set Rings are included to accommodate the drapery return. Additional available to order if required.

Available in all finishes



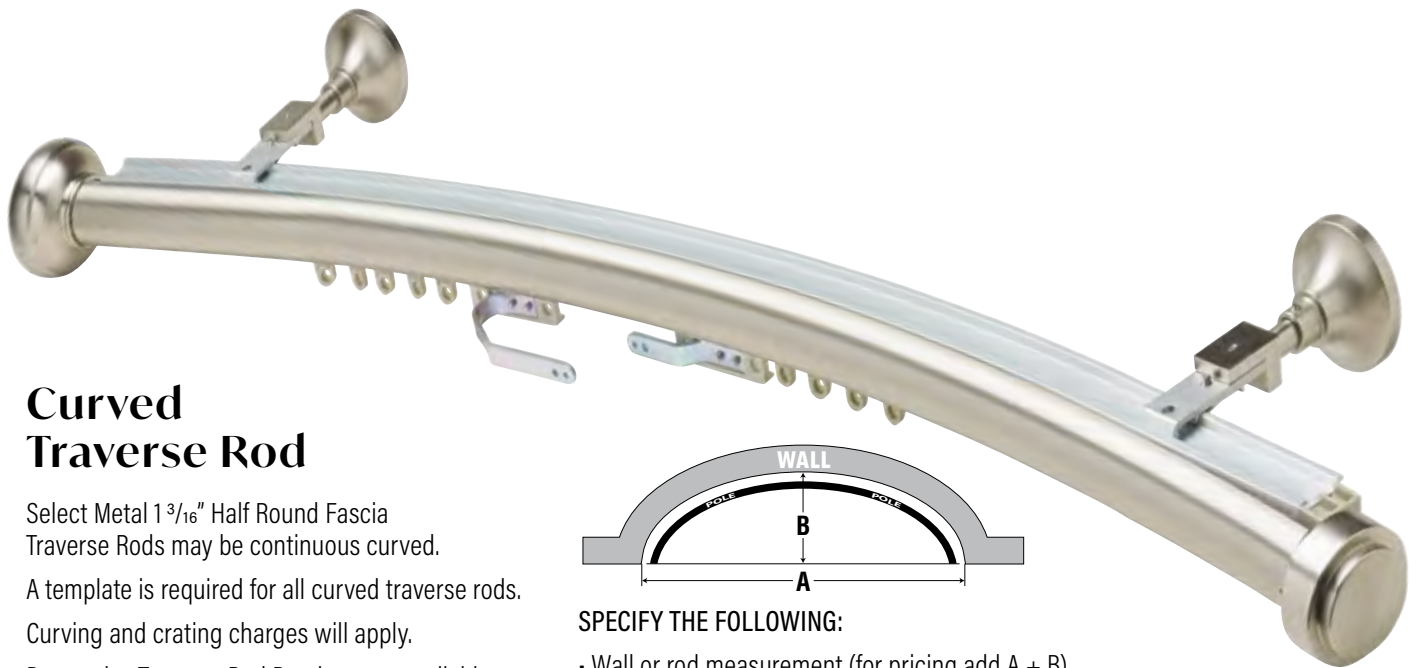

Curved Traverse Rod

Select Metal $1\frac{3}{16}$ " Half Round Fascia Traverse Rods may be continuous curved.

A template is required for all curved traverse rods.

Curving and crating charges will apply.

Decorative Traverse Rod Brackets are available for a surcharge.

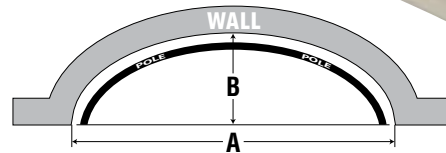

SPECIFY THE FOLLOWING:

- Wall or rod measurement (for pricing add A + B)
- Return and Bracket Style



Hinged Elbow

130-4053 ($1\frac{3}{16}$ " $2\frac{1}{8}$ " x $2\frac{1}{8}$ "

Hinged Elbows may be used for corner or bay window applications. Hinged Elbow attaches using the Finial Adaptor included with Traverse Rods.

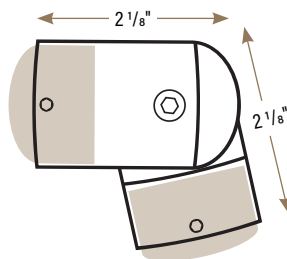

Double Traverse Rods

Available with back rod as "track only" or with Select Metal Fascia.



DECORATIVE TRAVERSE ROD BRACKETS

Available for a surcharge



Round Bracket

130-2064 Return: 4"

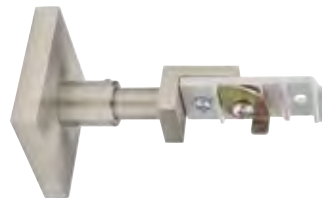
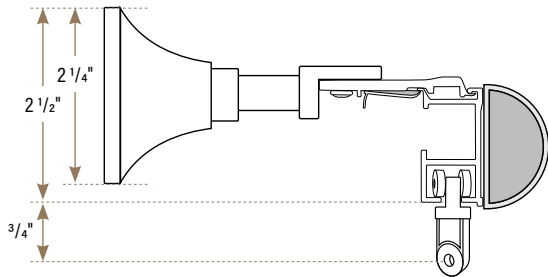

Square Bracket

130-2164 Return: 4"

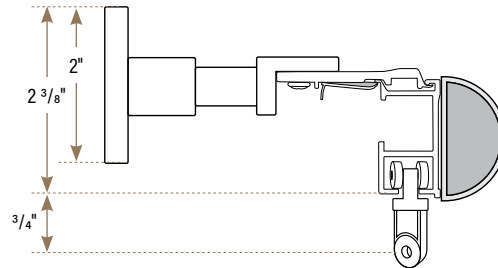

Round Extended Bracket

130-2066 Return: 5 1/2"



Square Extended Bracket

130-2166 Return: 5 1/2"

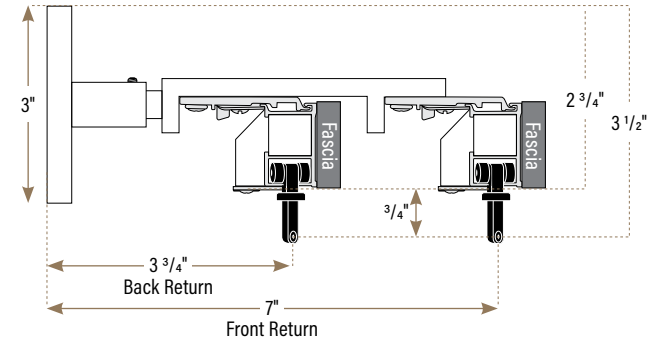
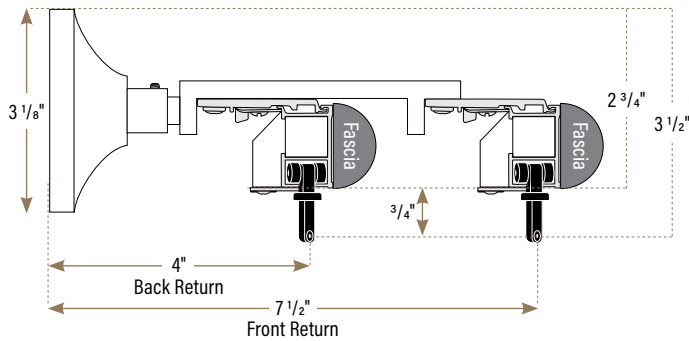

Round Double Bracket

130-2067 Front Return: 7 1/2", Back Return: 4"



Square Double Bracket

130-2167 Front Return: 7", Back Return: 3 3/4"

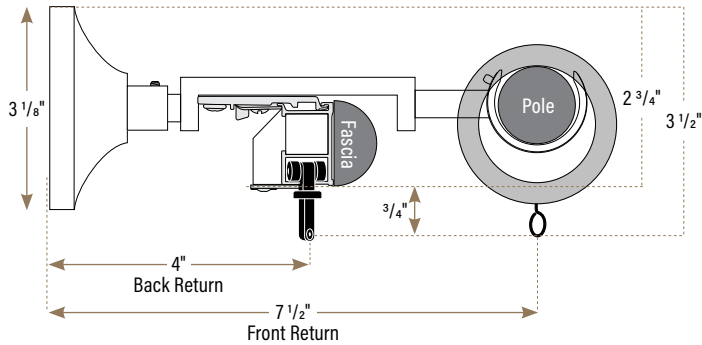
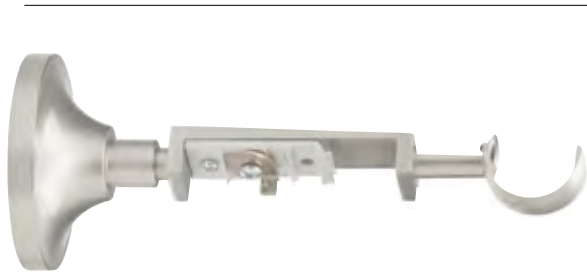

1 3/16" Combination Bracket

130-2097 Pole Return: 7 1/2", Back Rod Return: 4"

1 3/16" Select Metal Combination Brackets offer the flexibility to install a 1 3/16" Select Metal Pole with rings in front of a Traverse Rod.

Available in all finishes

STANDARD TRAVERSE ROD BRACKETS

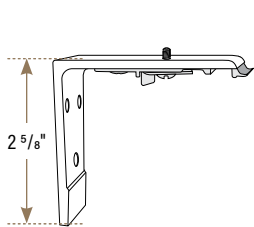

94123 Heavy Duty Single Wall Bracket

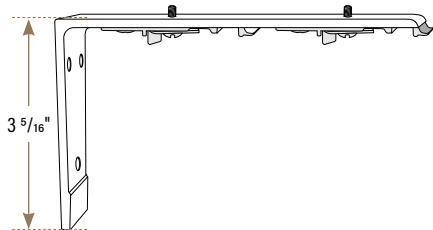

94125 Double Wall Mount Bracket or 6" Projection Bracket

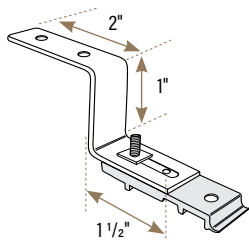

ZBK-1000Z Ceiling Mount Bracket



93633 Track Splice Clip



93630 Mounting Clip

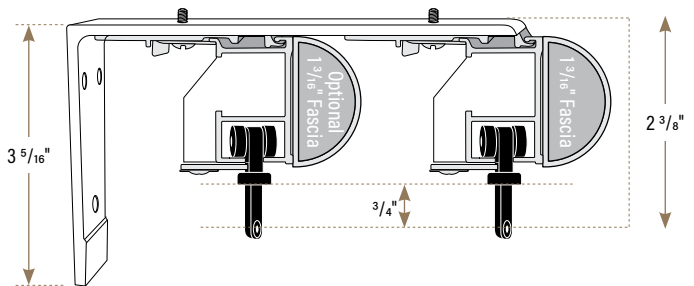

Pin Setting Diagram

Select Premium Tracks

Select Premium Tracks are available in 2 finishes: Bronze (17) and Aluminum (90). Select Metal Traverse Rods will be assembled with track finish as listed on right unless specified differently. Tracks are also available as assembled sets without decorative fascia.



Track Finish: Aluminum (90)

Fascia Finishes: Satin Brass (22), Steel (67), Polished Nickel (68), Gunmetal (65)



Track Finish: Bronze (17)

Fascia Finishes: Bronze (07), Brushed Brass (27), Graphite (48), Matte Black (46)

TRAVERSE RODS - Brass

Assembled to order.

Cord Draw standard. Hand Draw option includes Kirsch 36" White Fiberglass Baton. Coordinating Brass Batons are available and purchased separately. See Batons page 25.

Ripplefold® available – Must specify fullness.

Assembled set includes approximately 3.5 wheeled carriers per foot, heavy duty installation brackets, tension pulley, and finial attachment adaptor. Maximum continuous set length – 16 ft.

Finials and End Caps are not included. Please order separately.

All Decorative Brackets available for a surcharge.



WARNING
ADVERTENCIA

Window Treatment Cord Can STRANGLE Your Child. To prevent strangulation, purchase cordless products with inaccessible cords.



La cuerda de la persiana puede ESTRANGULAR a su niño. Para evitar el estrangulamiento, compre o productos con cuerdas inaccesibles.



Without Splice Cover



Fascia Splice Cover For Half Round Fascia

130-4009 L: 2 3/4"



With Splice Cover



Fascia Splice Cover For Metro Flat Fascia

135-4008 L: 2 3/4"



Without Splice Cover

Internal Splice

130-4099-67 1 3/16" Half Round Internal Splice

135-4088-67 Metro Internal Splice

Included with all spliced Traverse Rods



With Splice Cover



Bracket Details

DESCRIPTION	ITEM #	FINISHES	RETURNS	COMMENTS
Heavy Duty Single Wall Bracket - Standard	94123	25, 85, 90	3 1/2" - 4 1/2"	Can be painted to match wall color
Double or 6" Projection Bracket	94125	25, 85, 90	5 1/2"	Can be painted to match wall color
Round Decorative Traverse Rod Bracket	130-2064	All Brass finishes	4"	Surcharge applies
Round Decorative Ext. Traverse Rod Bracket	130-2066	All Brass finishes	5 1/2"	Surcharge applies
Round Double Decorative Traverse Rod Bracket	130-2067	All Brass finishes	7 1/2"	Surcharge applies
Square Decorative Traverse Rod Bracket	130-2164	All Brass finishes	4"	Surcharge applies
Square Decorative Ext. Traverse Rod Bracket	130-2166	All Brass finishes	5 1/2"	Surcharge applies
Square Double Decorative Traverse Rod Bracket	130-2167	All Brass finishes	7"	Surcharge applies
1 3/16" Combination Pole / Traverse Rod Bracket	130-2097	All Brass finishes	7 1/2"	Surcharge applies
Ceiling / Clip for Select Traverse Rods	93630	17, 90		
Track Splice Clip for Select Traverse Rods	93633	17, 90		
Ceiling Mount Bracket - 1" Drop	ZBK-1000Z	61		Includes 93630



CORTINA TRAVERSE ROD SETS

CORTINA TRAVERSE ROD SETS

The Cortina Traverse Rod Collection includes three unique and contemporary rod designs; Sintra, Coimbra, and Obidos Traverse Rods. These rods may be hand or cord draw and are made to exact measurements with brackets and end caps included.

Sintra, Coimbra, and Obidos each offer a unique track design. Sintra with a sleek 1" square track, Obidos a 1 1/8" rounded track, and Coimbra a 2 3/8" high track with a curved or flat face. Each style uses the same components and installation brackets.



Sintra

Sintra, Coimbra, and Obidos Traverse Rods Feature:

Heavy Duty Tracks.

Available for use with Pinch Pleat or Ripplefold Draperies.

Available in four finishes; Steel, Champagne, Black Gloss, and White Gloss.

Double Traverse Rod Sets are available.

Coordinating Brackets and End Caps are included in the set price.



Coimbra

Sintra, Coimbra, and Obidos Traverse Rod Assembled Sets

Traverse Rod Assembled Sets are made to exact measurements. Sets are priced by the foot and include End Caps, Brackets, Carriers, and Masters.

DRAPERY WEIGHT CAPACITY:

Pinch Pleat – 4 lbs. per foot, includes 3.5 heavy duty ball bearing carriers per foot.

Ripplefold – 2 lbs. per foot, assembled with Ripplefold Slide Carriers. Must specify fullness, 60%, 80%, 100%, or 120%. Use with standard Ripplefold Snap Tape. Overlap or Butt Masters are available.

Hand Draw or Cord Draw.

Cord Draw – **must specify Cord Drop.**

Hand Draw – Batons are not included and should be ordered separately.

Single and Double Rod Sets are available.

Double Rod Sets – front and back rods are the same track.

Maximum continuous set length – 236". Rods may be spliced for longer lengths or for shipping purposes. When spliced must be 2-way draw. **Splice included.**



Obidos

Sintra Traverse Rod Sets

Sintra Single Traverse Rod Height: 1", Maximum Continuous Length: 236"

Sintra Double Traverse Rod Height: 1", Maximum Continuous Length: 236"

End Caps are included in track length.

Single Wall Mount specify 3 1/2" or 6 1/4" Return

Rods may be spliced for longer lengths or for shipping purposes.

Sintra
Cord
Draw

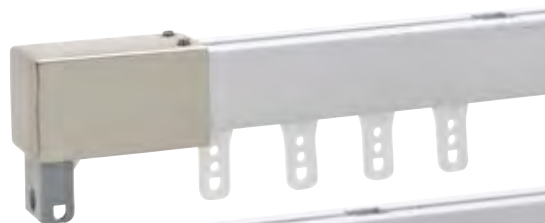

Sintra
Hand
Draw



Coimbra Traverse Rod Sets

Coimbra Single Traverse Rod Height: 2 3/8", Maximum Continuous Length: 236"

Coimbra Double Traverse Rod Height: 2 3/8", Maximum Continuous Length: 236"

End Caps are included in track length.

Single Wall Mount specify 3 1/2" or 6 1/4" Return

Rods may be spliced for longer lengths or for shipping purposes.

Coimbra
Cord
Draw

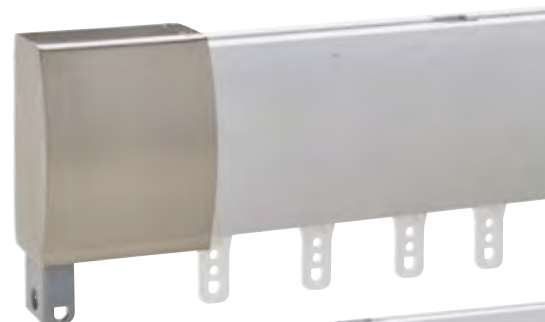

Coimbra
Hand
Draw



Coimbra Track Option

May be used with Curved Face or Flat Face to the front

Must be specified

Curved Face
to the front



Flat Face to
the front



Obidos Traverse Rod Sets

Obidos Single Traverse Rod Height: 1 1/8", Maximum Continuous Length: 236"

Obidos Double Traverse Rod Height: 1 1/8", Maximum Continuous Length: 236"

End Caps are included in track length.

Single Wall Mount specify 3 1/2" or 6 1/4" Return

Rods may be spliced for longer lengths or for shipping purposes.

Obidos
Cord
Draw



Obidos
Hand
Draw

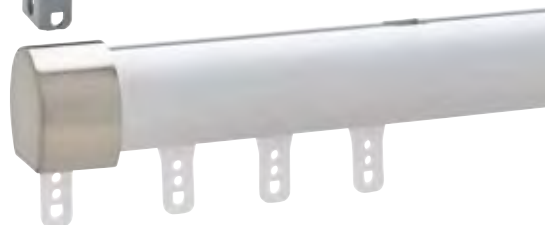

Cortina Finishes:



STEEL
(A, AP)



CHAMPAGNE
(BC)

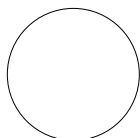

GLOSS WHITE
(BL)



GLOSS BLACK
(NB)

CORTINA TRAVERSE ROD BRACKETS



Single Wall Bracket

20.113 Return: 3 1/4", Projection: 4"
Available in all Cortina finishes



Single Extended Wall Bracket

20.115 Return: 6 1/4", Projection: 7"
Available in all Cortina finishes



Double Wall Bracket

25.115 Front Return: 6 1/4",
Back Return: 3 1/4", Projection: 7"
Available in all Cortina finishes



Flush Mount Ceiling Bracket

20.131 Drop: 1/4", White, Plastic



Ceiling Bracket

20.114 Width: 2 1/8", Drop: 2 1/4"
Available in all Cortina finishes

Brackets Included with Sets

DESCRIPTION	ITEM #	PROJECTION/DROP	RETURN	HEIGHT
Single Wall Bracket	20.113	4" Projection	3 1/2"	2 1/8"
Single Extended Wall Bracket	20.115	7" Projection	6 1/4"	2 1/8"
Double Wall Bracket	25.115	7" Projection	6 1/4"	2 1/8"
Ceiling Bracket	20.114	2 1/4" Drop	-	-
Flush Mount Ceiling Bracket	20.131	1/4" Drop	-	-

Ripplefold® Master Carriers

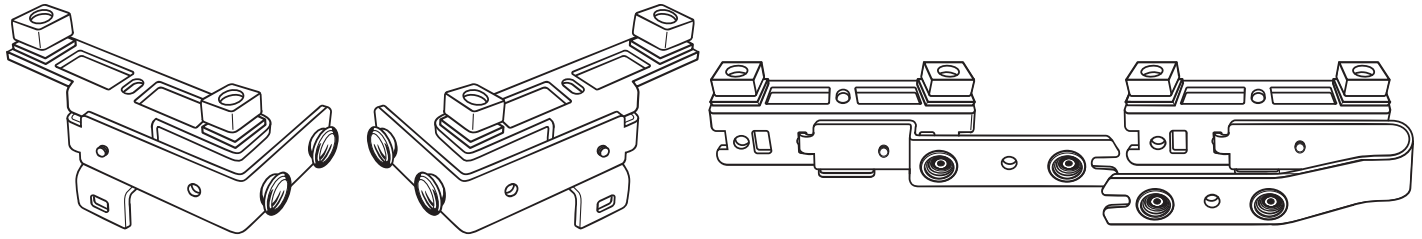

Ripplefold® Butt Masters - Snaps are 1" on Center

Ripplefold® Overlap Masters - Snaps are 1 3/8" on Center

Batons

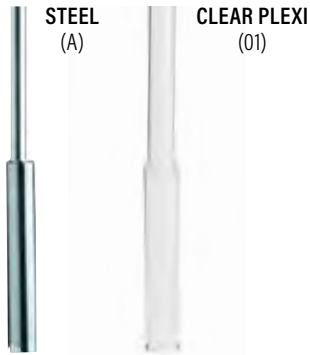

61.20 Metal Baton, Length: 39",
Diameter: 3/8"

500-4300 Heavy Duty Clear Plexi Baton,
Length: 39", Diameter: 1/2"

Batons available for a surcharge

Track Splice

15.05 Length: 3 5/8"

Included with spliced rods



ROD LENGTH	BRACKETS INCLUDED
Up to 60"	2 Brackets
61" to 90"	3 Brackets
91" to 120"	4 Brackets
121" to 150"	5 Brackets
151" to 180"	6 Brackets
181" to 210"	7 Brackets
211" to 236"	8 Brackets

Pin Hole Settings

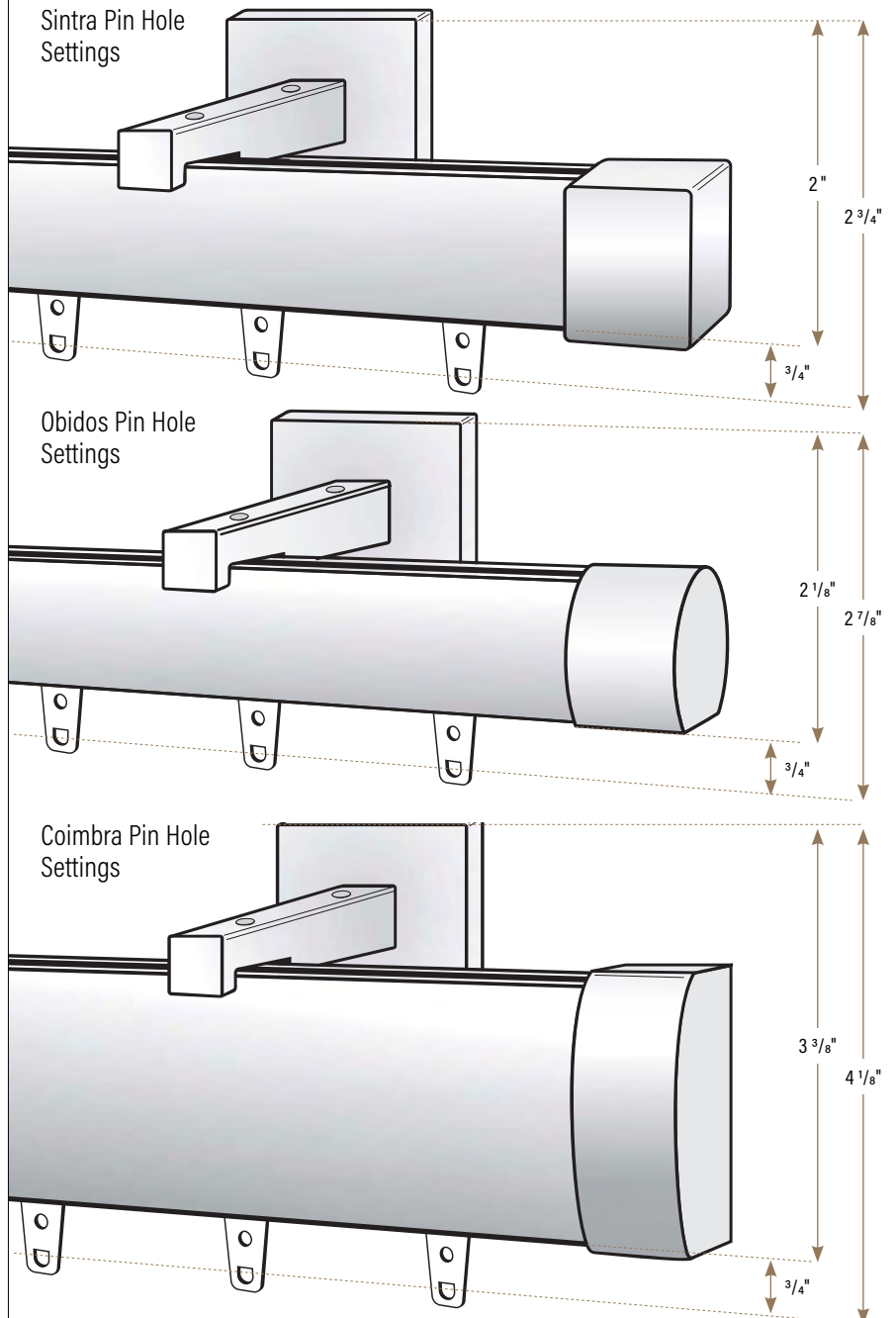

3/4" and 1 3/16"

IRON WORKS





3/4" and 1 3/16"

POLES - Iron Works

3/4" Iron Poles - 6'

120-0006-815	Black Copper
120-0006-845	Black
120-0006-857	Sandstone
120-0006-865	Black Pewter

3/4" Iron Poles - 8'

120-0008-815	Black Copper
120-0008-845	Black
120-0008-857	Sandstone
120-0008-865	Black Pewter

3/4" Iron Poles - 12'

120-0012-815	Black Copper
120-0012-845	Black
120-0012-857	Sandstone
120-0012-865	Black Pewter

1 3/16" Iron Poles - 6'

130-0006-815	Black Copper
130-0006-845	Black
130-0006-857	Sandstone
130-0006-865	Black Pewter

1 3/16" Iron Poles - 8'

130-0008-815	Black Copper
130-0008-845	Black
130-0008-857	Sandstone
130-0008-865	Black Pewter

1 3/16" Iron Poles - 12'

130-0012-815	Black Copper
130-0012-845	Black
130-0012-857	Sandstone
130-0012-865	Black Pewter



Internal Pole Splice

- 120-4999-67 (3/4")
- 130-4999-67 (1 3/16")

Iron Works Finishes:

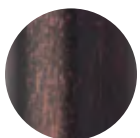

BLACK COPPER
(815)



BLACK
(845)



SANDSTONE
(857)



BLACK PEWTER
(865)

3/4" and 1 3/16"

FINIALS - Iron Works



End Cap

3/4" - L: 5/8" x H: 7/8"
1 3/16" - L: 3/4" x H: 1 3/8"



Capri End Cap

3/4" - L: 5/8" x H: 1 3/8"
1 3/16" - L: 3/4" x H: 2"



Ball Finial

3/4" - L: 2 3/4" x H: 1 3/4"
1 3/16" - L: 3 5/8" x H: 2 1/4"

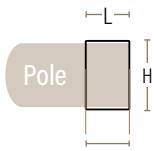

3/4" Pole Inset - 1/2" • 1 3/16" Pole Inset - 5/8"

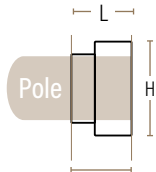

3/4" Pole Inset - 5/8" • 1 3/16" Pole Inset - 5/8"

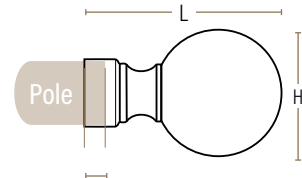

3/4" Pole Inset - 1/2" • 1 3/16" Pole Inset - 1/2"



BLACK COPPER
120-1060-815 (3/4")
130-1060-815 (1 3/16")



BLACK
120-1060-845 (3/4")
130-1060-845 (1 3/16")



SANDSTONE
120-1060-857 (3/4")
130-1060-857 (1 3/16")



BLACK PEWTER
120-1060-865 (3/4")
130-1060-865 (1 3/16")



BLACK COPPER
120-1062-815 (3/4")
130-1062-815 (1 3/16")



BLACK
120-1062-845 (3/4")
130-1062-845 (1 3/16")



SANDSTONE
120-1062-857 (3/4")
130-1062-857 (1 3/16")



BLACK PEWTER
120-1062-865 (3/4")
130-1062-865 (1 3/16")



BLACK COPPER
120-1061-815 (3/4")
130-1061-815 (1 3/16")



BLACK
120-1061-845 (3/4")
130-1061-845 (1 3/16")



SANDSTONE
120-1061-857 (3/4")
130-1061-857 (1 3/16")



BLACK PEWTER
120-1061-865 (3/4")
130-1061-865 (1 3/16")

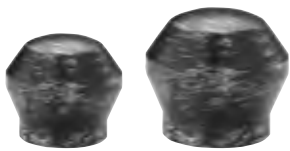

Argo Finial

$\frac{3}{4}$ " - L: 1 $\frac{1}{4}$ " x H: 1 $\frac{3}{8}$ "
 1 $\frac{3}{16}$ " - L: 2 $\frac{3}{8}$ " x H: 2 $\frac{1}{2}$ "



Avalon Finial

$\frac{3}{4}$ " - L: 5" x H: 2"
 1 $\frac{3}{16}$ " - L: 5 $\frac{5}{8}$ " x H: 2 $\frac{1}{2}$ "



Cypress Finial

$\frac{3}{4}$ " - L: 3 $\frac{1}{4}$ " x H: 1 $\frac{7}{8}$ "
 1 $\frac{3}{16}$ " - L: 4 $\frac{1}{8}$ " x H: 2 $\frac{3}{8}$ "

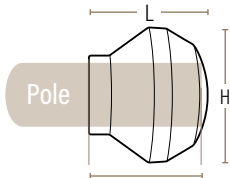

$\frac{3}{4}$ " Pole Inset - 1" • 1 $\frac{3}{16}$ " Pole Inset - 2"

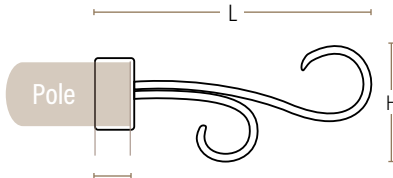

$\frac{3}{4}$ " Pole Inset - $\frac{1}{2}$ " • 1 $\frac{3}{16}$ " Pole Inset - $\frac{1}{2}$ "

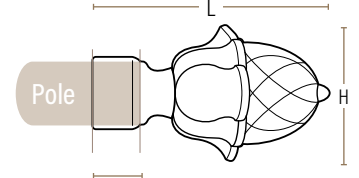

$\frac{3}{4}$ " Pole Inset - $\frac{1}{2}$ " • 1 $\frac{3}{16}$ " Pole Inset - $\frac{5}{8}$ "



BLACK COPPER
 120-1063-815 ($\frac{3}{4}$ ")
 130-1063-815 (1 $\frac{3}{16}$ ")



BLACK
 120-1063-845 ($\frac{3}{4}$ ")
 130-1063-845 (1 $\frac{3}{16}$ ")



SANDSTONE
 120-1063-857 ($\frac{3}{4}$ ")
 130-1063-857 (1 $\frac{3}{16}$ ")

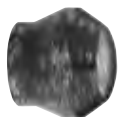

BLACK PEWTER
 120-1063-865 ($\frac{3}{4}$ ")
 130-1063-865 (1 $\frac{3}{16}$ ")



BLACK COPPER
 120-1064-815 ($\frac{3}{4}$ ")
 130-1064-815 (1 $\frac{3}{16}$ ")



BLACK
 120-1064-845 ($\frac{3}{4}$ ")
 130-1064-845 (1 $\frac{3}{16}$ ")



SANDSTONE
 120-1064-857 ($\frac{3}{4}$ ")
 130-1064-857 (1 $\frac{3}{16}$ ")



BLACK PEWTER
 120-1064-865 ($\frac{3}{4}$ ")
 130-1064-865 (1 $\frac{3}{16}$ ")



BLACK COPPER
 120-1065-815 ($\frac{3}{4}$ ")
 130-1065-815 (1 $\frac{3}{16}$ ")



BLACK
 120-1065-845 ($\frac{3}{4}$ ")
 130-1065-845 (1 $\frac{3}{16}$ ")



SANDSTONE
 120-1065-857 ($\frac{3}{4}$ ")
 130-1065-857 (1 $\frac{3}{16}$ ")



BLACK PEWTER
 120-1065-865 ($\frac{3}{4}$ ")
 130-1065-865 (1 $\frac{3}{16}$ ")

3/4" and 1 3/16"

FINIALS - Iron Works



Royal Finial

3/4" - L: 5" x H: 2 5/8"
1 3/16" - L: 5" x H: 2 5/8"



Valor Finial

3/4" - L: 2" x H: 1 3/8"
1 3/16" - L: 2 5/8" x H: 2"



Grenada Finial

3/4" - L: 1 5/8" x H: 1 3/4"
1 3/16" - L: 2 1/4" x H: 2 3/8"

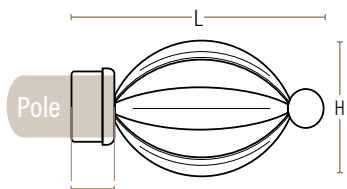

3/4" Pole Inset - 3/8" • 1 3/16" Pole Inset - 5/8"

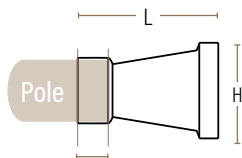

3/4" Pole Inset - 3/8" • 1 3/16" Pole Inset - 1/2"

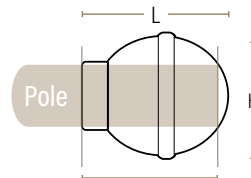

3/4" Pole Inset - 1 1/8" • 1 3/16" Pole Inset - 2 1/8"



BLACK COPPER

120-1066-815 (3/4")
130-1066-815 (1 3/16")



BLACK

120-1066-845 (3/4")
130-1066-845 (1 3/16")



SANDSTONE

120-1066-857 (3/4")
130-1066-857 (1 3/16")



BLACK PEWTER

120-1066-865 (3/4")
130-1066-865 (1 3/16")



BLACK COPPER

120-1067-815 (3/4")
130-1067-815 (1 3/16")



BLACK

120-1067-845 (3/4")
130-1067-845 (1 3/16")



SANDSTONE

120-1067-857 (3/4")
130-1067-857 (1 3/16")



BLACK PEWTER

120-1067-865 (3/4")
130-1067-865 (1 3/16")



BLACK COPPER

120-1068-815 (3/4")
130-1068-815 (1 3/16")



BLACK

120-1068-845 (3/4")
130-1068-845 (1 3/16")



SANDSTONE

120-1068-857 (3/4")
130-1068-857 (1 3/16")



BLACK PEWTER

120-1068-865 (3/4")
130-1068-865 (1 3/16")

3/4" and 1 3/16"

FRENCH RETURNS - Iron Works



BLACK COPPER (815)



SANDSTONE (857)



BLACK (845)

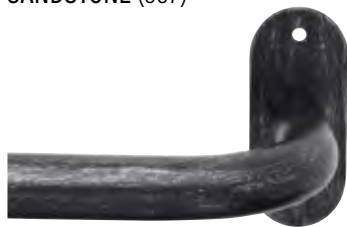

BLACK PEWTER (865)

French Return Elbow

120-4063 (3/4") Return: 3 1/4", Projection: 4", Length: 5"

130-4063 (1 3/16") Return: 3 1/2", Projection: 4 3/8", Length: 5"



Internal Connector

Used to connect the elbow to the pole.
Included

French Return Set Ring

120-3966 (3/4")

130-3966 (1 3/16")

Available in all Iron Works finishes



Center Support Options

A Center Support Bracket is required for all French Return installations.

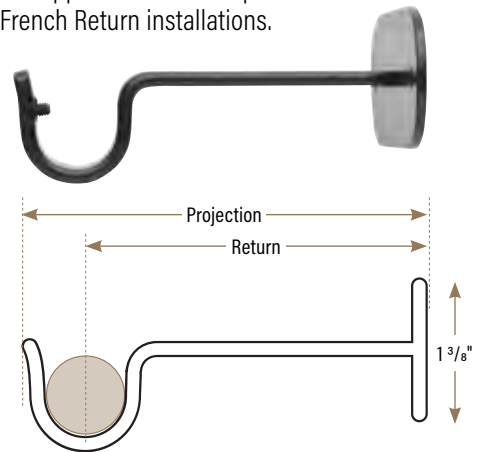

Center Support Bracket

120-2613 (3/4") Return: 3 1/4", Projection: 4"

130-2613 (1 3/16") Return: 3 1/2", Projection: 4 3/8"

Available in all Iron Works finishes

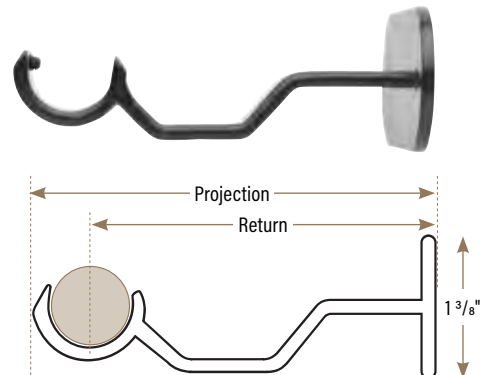

By-Pass Center Support Bracket

120-2623 (3/4") Return: 3 1/4", Projection: 4"

130-2623 (1 3/16") Return: 3 1/2", Projection: 4 3/8"

Available in all Iron Works finishes

3/4" and 1 3/16"

BRACKETS

- Iron Works

Standard Ceiling Bracket

120-2653 (3/4") Drop: 2 3/4"
 130-2653 (1 3/16") Drop: 3 1/4"
 Available in all Iron Works finishes

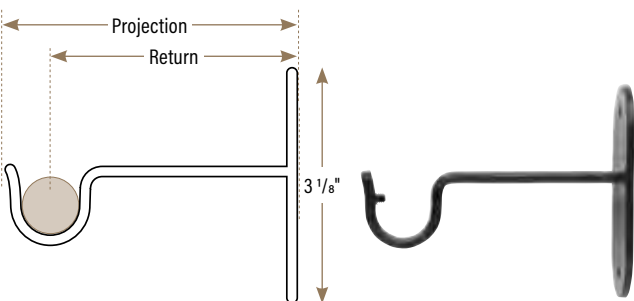
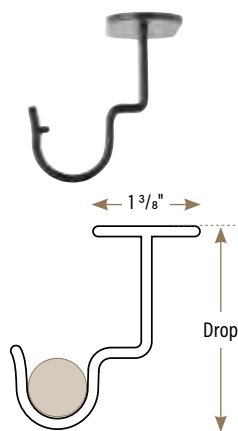

Wall Bracket

120-2603 (3/4") Return: 3 1/4", Projection: 4"
 130-2603 (1 3/16") Return: 3 1/2", Projection: 4 3/8"
 Available in all Iron Works finishes



Extended Wall Bracket

120-2606 (3/4") Return: 5 1/2", Projection: 6 1/4"
 130-2606 (1 3/16") Return: 5 3/4", Projection: 6 1/2"
 Available in all Iron Works finishes

Inside Mount Recess Bracket

120-2000 (3/4") L: 3/4" x H: 1 1/4", Pole Inset - 1/2"
 130-2000 (1 3/16") L: 1" x H: 1 3/4", Pole Inset - 3/4"
 Available in all Iron Works finishes

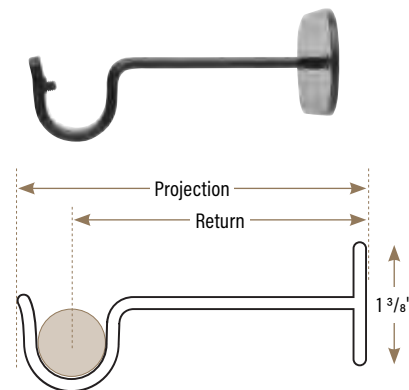
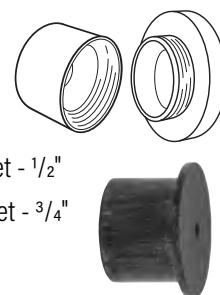

Center Support Bracket

120-2613 (3/4") Return: 3 1/4", Projection: 4"
 130-2613 (1 3/16") Return: 3 1/2", Projection: 4 3/8"
 Available in all Iron Works finishes



Extended Center Support Bracket

120-2616 (3/4") Return: 5 1/2", Projection: 6 1/4"
 130-2616 (1 3/16") Return: 5 3/4", Projection: 6 1/2"
 Available in all Iron Works finishes

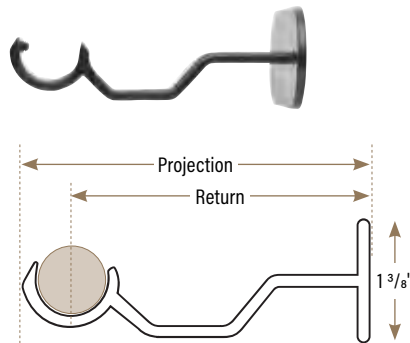
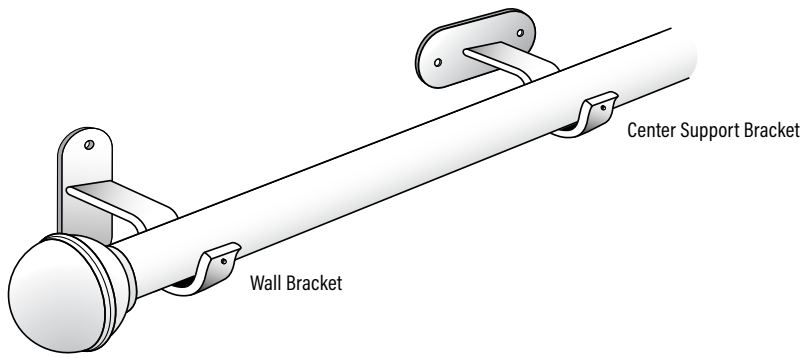

By-Pass Center Support Bracket

120-2623 (3/4") Return: 3 1/4", Projection: 4"

130-2623 (1 3/16") Return: 3 1/2", Projection: 4 3/8"

Available in all Iron Works finishes



Extended By-Pass Center Support Bracket

120-2626 (3/4") Return: 5 1/2", Projection: 6 1/4"

130-2626 (1 3/16") Return: 5 3/4", Projection: 6 1/2"

Available in all Iron Works finishes

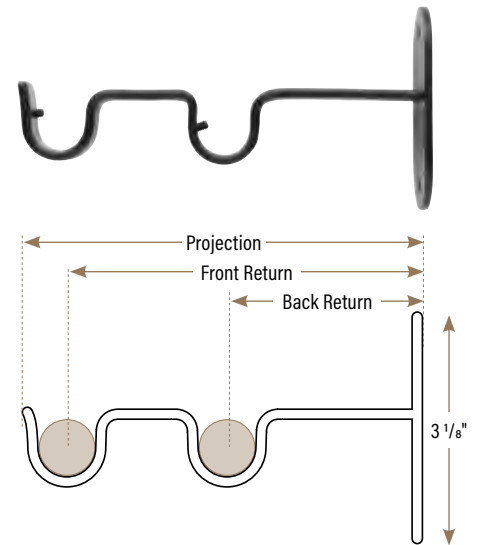

Double Wall Bracket

120-2636 (3/4") Front Pole: 3/4", Back Pole: 3/4"
Front Return: 5 1/2", Back Return: 3 1/8", Projection: 6 1/4"

130-2636 (1 3/16") Front Pole: 1 3/16", Back Pole: 1 3/16"
Front Return: 6 1/4", Back Return: 3 3/8", Projection: 7"

Available in all Iron Works finishes



Double Center Support Bracket

120-2646 (3/4") Front Pole: 3/4", Back Pole: 3/4"
Front Return: 5 1/2", Back Return: 3 1/8", Projection: 6 1/4"

130-2646 (1 3/16") Front Pole: 1 3/16", Back Pole: 1 3/16"
Front Return: 6 1/4", Back Return: 3 3/8", Projection: 7"

Available in all Iron Works finishes

Iron Works Finishes:

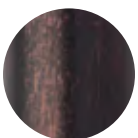

BLACK COPPER
(815)



BLACK
(845)



SANDSTONE
(857)



BLACK PEWTER
(865)



3/4" and 1 3/16"
ACCESSORIES
- Iron Works

Hinged Elbow

120-4053 (3/4")
1 3/4" x 1 3/4", Pole Inset: 5/8"

130-4053 (1 3/16")
2 1/8" x 2 1/8", Pole Inset: 5/8"



3/4" and 1 3/16"

RINGS - Iron Works



Round Iron Ring with Liner

120-3700 (3/4") I.D.: 1 1/8", O.D.: 1 5/8"

130-3700 (1 3/16") I.D.: 1 5/8", O.D.: 2 3/8"

Available in all Iron Works finishes



Flat By-Pass Iron Ring with Liner

120-3400 (3/4") I.D.: 1 1/4", O.D.: 1 5/8"

130-3400 (1 3/16") I.D.: 1 5/8", O.D.: 2 3/8"

Available in all Iron Works finishes



Flat Ring with Liner

120-3600 (3/4") I.D.: 1 1/8", O.D.: 1 1/2"

130-3600 (1 3/16") I.D.: 1 3/4", O.D.: 2"

Available in all Iron Works finishes

Batons



500-4600 39" Iron Baton



Iron Works Finishes:

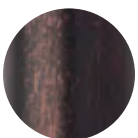

BLACK COPPER
(815)



BLACK
(845)



SANDSTONE
(857)



BLACK PEWTER
(865)

SALES AIDS

Product Binder



2019SWB



2017SELM

Finish Selector

Table Top Displays



2020SELM



2017SELM

Wall Displays

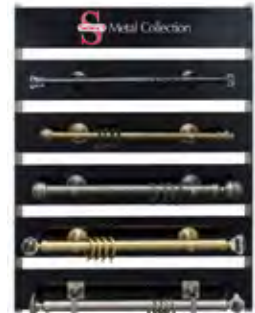

2020SELMDB1 - BRASS



2020SELMDB2 - BRASS



2017SELMWDB - IRON WORKS

LIFETIME LIMITED WARRANTY

Selective Enterprises, Inc. provides a lifetime limited warranty on all Select Drapery Hardware and Select Traverse Rods. Selective Enterprises, Inc. warrants that these products will be free from defects due to faulty workmanship or materials. This warranty extends to the original residential retail purchaser.

If a Selective Enterprises, Inc. product is found to be defective during the warranty period we will, at our discretion, repair or replace the defective product at no charge. Repair or replacement of defective products is the sole remedy under this warranty. In no event shall Selective Enterprises, Inc. be liable for costs to remove, replace, transport, or reinstall products purchased from Selective Enterprises. Furthermore, Selective Enterprises will not be responsible for any incidental or consequential damages.

This warranty does not cover normal wear and tear or any damage or loss by accidents, alterations, improper use, abuse, neglect, improper installation, cleaning, or other maintenance. The warranty shall be void if product is moved from its original installed location. Select products may gradually lose color intensity after long exposure to direct sun. This color loss is not covered by the warranty.

All cords eventually wear out. This is considered normal wear and tear not covered by warranty. The warranty does not cover removal, installation, replacement, or shipping costs.



SELECT WOOD COLLECTION

Select Drapery Hardware also includes the Select Wood Collection. Select Wood includes a choice of thirteen stunning finishes for 1 ³/₈" and 2 ¹/₄" poles, traverse rods, and accessories.

The Select Wood Collection is included in the Select Drapery Hardware Product Binder, 2019SWB, and can also be viewed on the Select Drapery Hardware website.



www.selectdraperyhardware.com



Midwest
Designer
Supply

www.midwestdesignersupply.com

888-523-2611
262-524-1007 (fax)



2021SMB-D